

Workers' tool or PR ploy?

4th revised edition



**A guide to codes
of international
labour practice**

By Ingeborg Wick



**FRIEDRICH
EBERT
STIFTUNG**

**INSTITUT FÜR
ÖKONOMIE
UND ÖKUMENE**
südwind

Workers' tool or PR ploy?

A guide to codes of international labour practice

BY INGEORG WICK

Friedrich-Ebert-Stiftung / Bonn, Germany

SÜDWIND Institut für Ökonomie und Ökumene / Siegburg, Germany

2005

Published jointly by

Friedrich-Ebert-Stiftung,
Godesberger Allee 149, 53175 Bonn
and

SÜDWIND Institut für Ökonomie und Ökumene,
Lindenstraße 58–60, 53721 Siegburg

Author

Ingeborg Wick

Cover design and layout:

Frank Zander

Printed by

Bonner Universitätsdruckerei
Bonn/Siegburg 2005

ISBN 3-86077-979-6

4th revised edition

Table of contents

PREFACE	5
1. INTRODUCTION	6
2. RESTRUCTURING OF THE WORLD ECONOMY	11
3. BASIC INFORMATION ON TRADE-RELATED INITIATIVES	15
3.1 Ethical consumption	15
3.2 WTO and Workers' Rights	17
3.3 International Framework Agreements	20
3.4 World Works Councils and Global Union Networks	23
3.5 Codes of Conduct	25
4. PROFILES OF MULTISTAKEHOLDER INITIATIVES	32
4.1 Fair Wear Foundation	32
4.2 Social Accountability International	39
4.3 Ethical Trading Initiative	46
4.4 Fair Labor Association	54
4.5 Worker Rights Consortium	61
4.6 Overview and Comparison / Joint Initiative	70





Preface to the 4th revised edition

Since the first publication of “Workers’ tool or PR ploy?” in March 2001, the international debate on codes of conduct has gained further momentum. This debate reflects a growing worldwide movement questioning the social impact of globalisation.

According to the ILO World Commission on the Social Dimension of Globalisation which published its findings in early 2004, globalisation has denied the vast majority of women and men decent jobs and a better future for their children.

Since the beginning of the 90s, a whole range of new instruments aimed at the improvement workers’ rights, such as codes of conduct, international framework agreements and world works councils, have been developed. They were initiated by trade unions and civil society organisations as a supplement, and not an alternative, to government regulation. However, more and more businesses and governments promote the concept of voluntary “Corporate Social Responsibility” as an alternative to binding labour legislation. Yet, to counter further social polarisation, both public and private regulation will be necessary, and care should be taken to make them complement each other in practice.

This publication is centred on the profiles of five prominent code verification initiatives. During the past months, they have shown converging tendencies, despite their varied differences. The common ground is currently being explored in a “Joint Initiative on Corporate Accountability and Workers’ Rights” including the Clean Clothes Campaign aimed at strengthening the coordination and cooperation between these initiatives. Further harmonisation of code of conduct efforts will be needed to fully exploit the potential of this tool for the benefit of workers.

The first, second and third editions of this booklet have been translated into several languages and were used for worker education programmes in different countries. May the fourth revised edition also serve this purpose, and contribute to turning codes of conduct into useful tools in the hands of workers.

Friedrich Ebert Stiftung & SÜDWIND Institut für Ökonomie und Ökumene

5.	PRIVATE CODE OF CONDUCT INITIATIVES WITH EMPHASIS ON THE APPAREL AND SPORTSSHOE INDUSTRY . . .	89
5.1	Clean Clothes Campaign	89
5.2	Charter of the European Social Partners of the Textile and Clothing Sector.	91
5.3	Worldwide Responsible Apparel Production	92
5.4	Business Social Compliance Initiative	93
5.5	ISO.	94
6.	RECENT CODE OF CONDUCT INITIATIVES OF INTER-GOVERNMENTAL ORGANISATIONS AND THE EU	95
6.1	Revised OECD Guidelines for Multinational Enterprises	95
6.2	UN Global Compact	97
6.3	EU policy on CSR.	99
6.4	UN Norms.	100
7.	PERSPECTIVES	101
8.	THE NEW CODES OF CONDUCT	
	SOME QUESTIONS AND ANSWERS FOR TRADE UNIONISTS	
	By Neil Kearney and Dwight W. Justice	105
9.	APPENDIX	128
	List of Selected ILO Conventions	128
	Abbreviations.	129
	Glossary	131
	Bibliography.	132
	Contact addresses	136



1. Introduction

During the past 30 years, a new social movement has emerged in many countries to concern itself with the improvement of world-wide labour conditions in addition to the trade union movement.

This development has unfolded against the background of the radical restructuring of the world economy since the 1970s. This restructuring has been accompanied by intensified social degradation – especially in developing, but also in industrialised countries – as well as increasing environmental destruction and discrimination against women. These processes are often intertwined. New forms of resistance developed: the ecological and women’s movements gained momentum and new social alliances were formed. In 1992 for instance, when the UN Conference on Environment and Development took place in Rio de Janeiro, a broad network of environmental and development organisations, unions, other labour-related organisations and women’s groups conducted parallel conferences and lobbying activities to voice their concerns. Since then,

Export-Processing Zone in San Salvador



(M. ROSERY/CIR)

networking has increasingly taken place between new and traditional formations in societies around the world – not only during UN world conferences in the 90s, but also in connection with leading financial and economic institutions like the World Bank, the International Monetary Fund (IMF), the World Trade Organisation (WTO) and the Organisation for Economic Cooperation and Development (OECD). Since 2001, the high-ranking conferences of the World Economic Forum have been accompanied by World Social Forums in Porto Alegre with tens of thousands of participants from around the world challenging the impact of neoliberal globalisation. The international ATTAC movement is spreading worldwide with its demands for democratic control of financial markets and a fundamental shift of the world economy.

Ethical production and consumption is the aim of several trade-related initiatives launched in recent years, including alternative trade, social labeling, WTO campaigns, framework agreements world works councils, global union networks and codes of conduct. These initiatives are formidable challenges to the traditional workers’ movement.

This brochure deals with the potential of new social alliances in the field of trade-related initiatives focusing on codes of conduct.

In the early 1970s, **alternative trade** organisations established direct trade links with producers from developing countries and offered them better conditions than those obtainable from ordinary trading companies. Consumers in northern countries began to apply ethical criteria to their shopping, choosing products from developing countries to help improve the working and living conditions of those who produced these goods. Ethical consumption in support of ethical production and trade was embraced by a broad movement of solidarity, church, consumers and women’s groups, which centred their activities around thousands of “one-world shops” in the Netherlands, Switzerland, Germany, Sweden and elsewhere. Although the overall market share of ethically traded goods remains rather small, the one-world-shop movement in the North with its links to southern partners has become a stable political factor in many societies of the world today.

Arising from this movement, **social label** organisations and products gradually penetrated traditional commerce. More and more products from developing countries with independent labels (coffee, tea, cocoa, honey, sugar, bananas,



Garment factory in Mauritius

orange juice, carpets, flowers, etc.) are now being sold to industrial world consumers in supermarkets, schools and company canteens. While their market share admittedly remains modest in most cases, it is nevertheless no longer possible to ignore the political role of the fair trade movement in questioning the current world trade system.

In the 1980s, world-wide criticism of the GATT (General Agreement on Tariffs and Trade) regime increased in the light of the growing impoverishment of indebted developing countries. When the **WTO** took over as the GATT successor organisation in 1995, its intensified liberalisation policy and disregard of social disparities in world trade provoked wider protests. International networks of non-governmental organisations (NGOs) and unions were formed. They successfully opposed the opening of the WTO millennium round in Seattle, USA in December 1999. Previously, the 1995 UN Social Summit in Copenhagen had already proved that opposition to the WTO trade regime was shared not only by NGOs, unions and international organisations, but also by a number of governments.

At present, union campaigns for the respect of workers' rights in the framework of the WTO are not only centred on the direct link of trade and labour standards, but also on subjects such as democratic governance, debt relief, poverty eradication and environmental protection. A number of NGOs, however, support the resistance of some developing countries against the integration of social and environmental standards in trade agreements since this would hamper export opportunities and result in protectionism of industrialised countries.

The intensifying internationalisation of production and the growing social marginalisation of millions of people during the past two decades (especially in developing countries, but also in industrialised countries) caused unions and their international umbrella organisations to start developing a series of **International Framework Agreements**. These agreements between Global Union Federations (formerly International Trade Secretarits) and transnational corporations (TNCs), as well as World Works Councils and Global Union Networks, are a direct union response to the new demands of an economy undergoing globalisation.

Codes of conduct for TNCs which have been proliferating since the early 1990s, represent another new kind of challenge to the international labour movement. Their roots go back to the conventions of the ILO, the OECD "Guidelines for Multinational Enterprises" of 1976, the ILO "Tripartite Declaration of Principles concerning Multinational Enterprises and Social Policy" of 1977 and a number of similar codes in the 1970s, all of which lacked enforcement mechanisms and too often failed to produce positive results in practice. But these failings are not the only reason for the avalanche of codes of conduct produced since the early 1990s. They are also a response to more recent developments and require new explanations.

Codes of conduct are the main subject of this brochure, both because they are increasingly favoured by TNCs and governments and because considerable confusion exists among workers and NGOs about the pros and cons of this instrument. In order to exploit the opportunities offered by codes of conduct, it is necessary to know their background, role, limitations, advantages and main features, as well as to study a number of examples.

A comparison of current prominent code verification bodies is therefore at the heart of this brochure (chapter 4) as well as an analysis of the International

Confederation of Free Trade Unions (ICFTU) and the International Textile, Garment & Leather Workers' Federation (ITGLWF) entitled, "The new codes of conduct. Some questions and answers for trade unions" (chapter 8).

Before going into the details of codes of conduct, the brochure will offer a closer look at the socio-economic context in which they operate and provide some basic information on the above-mentioned trade-related initiatives.



Watch-tower in the
Export-Processing
Zone KBN/Jakarta,
Indonesia

(I. Wick)

2. Restructuring of the world economy

Since the 1970s, the Fordistic economic model followed by Western economic policies since the end of World War I has slowly been phased out and replaced by neoliberalism. Fordism was marked by steady economic growth, high profit rates, steady wage increases, low unemployment and increasing consumer spending power. Most citizens of industrialised countries were protected by social services and institutions, while most of the developing world was set to achieve this aim. With the rise of neoliberalism, however, the influence of private capital was strengthened by the policy of liberalisation and deregulation. Globalisation has become equated with the global application of the "Washington Consensus" principles consisting of the liberalisation of financial markets, trade and investment, the reduction in the size and role of the public sector especially regarding its labour market and social policy.

Since 1972, the liberalisation of the financial markets has produced literally spectacular results, exerting an increasing pressure on all other economic activities in the world. Daily financial transactions by thousands of banks and currency traders amount to more than US \$ 1.5 trillion, most of it in the form of speculation. During the past few years, due to the volatility of the financial flows, a number of countries and whole regions such as Southeast Asia or Argentina have been exposed to massive financial crises and huge social losses of millions of people.

The UNCTAD "World Investment Report 2004" highlights an increased influence of transnational corporations (TNCs) during the past years, revealing that in 2003 the sales of about 900,000 foreign affiliates of 61,000 TNCs reached US \$ 17.6 trillion (as compared to US \$ 9.5 trillion in 1990) – the equivalent of one-tenth of world Gross Domestic Product and one-third of world exports. (UNCTAD 2004) This UNCTAD report states: "The growth of international production systems reflects the response of TNCs to dramatic changes in the global economic environment: technological change, policy liberalization and increased competition. Falling barriers to international transactions allow TNCs to locate different parts of their production processes, including various service

functions, across the globe, to take advantage of fine differences in costs, resources, logistics and markets. (...) Global markets therefore increasingly involve competition between entire production systems, orchestrated by TNCs, rather than between individual factories or firms." (UNCTAD 2002)

Developed countries account for over 90% of total outward foreign direct investment. Since the mid-80s, the share of developing countries in the global flow of foreign direct investment has risen from less than 6% to some 11% during the latter half of the 90s, before falling to 7% during 2001–2003. (UNCTAD 2004) The bulk of these developments were concentrated in a few countries such as China, Singapore, Mexico and South Africa. The group of 50 least developed countries (LDCs) continued to receive little foreign direct investment which made up less than 2%. (UNCTAD 2004)

In 2003, the continuing liberalisation of the foreign direct investment regime led to 244 changes in laws and regulations, 220 of which were in the direction of more liberalisation. In that year, 86 bilateral investment treaties and 60 double taxation treaties were concluded, bringing the totals to 2,265 and 2,316, respectively.

Developing countries do not only suffer from the marked asymmetry of international FDI flows. In cases of increasing investments they also do not necessarily profit from more value added. The activities of TNCs are seldom rooted in host countries.

International trade has doubled its share of global income since 1970 and now accounts for about a quarter of world GDP. Intra-firm trade has increased from about a fifth to over one-third of total trade over the same period. (UNCTAD 2003) The trade expansion did not occur uniformly, with industrialised countries and 12 developing countries accounting for the lion's share. In contrast, the majority of developing countries did not experience

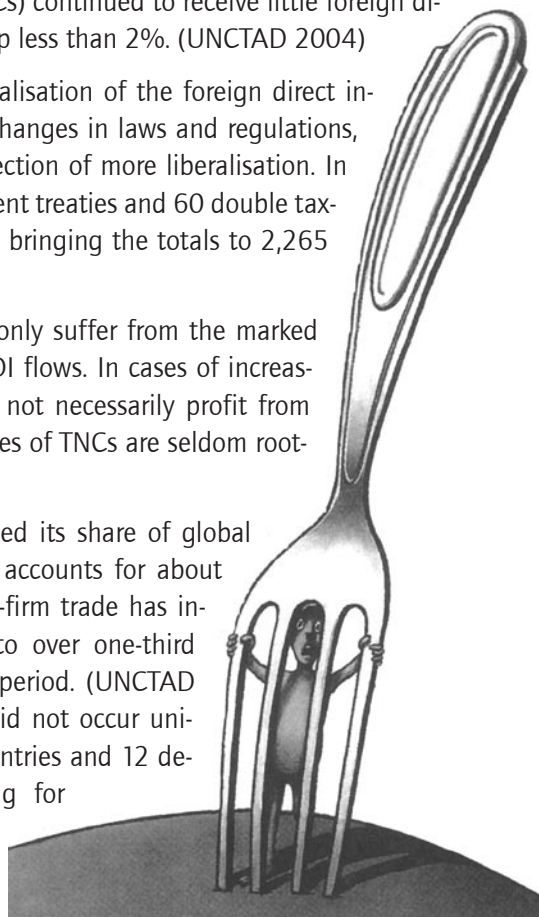

significant trade expansion. Most of the LDCs even experienced a proportional decline in their share of world markets. (ILO 2004)

As a result of neoliberal globalisation, the gap between the rich and the poor is widening all over the world. In 1960, the income gap of the 20% richest and 20% poorest people was 30 : 1. This rose to 60 : 1 in 1990, and to around 75 : 1 at the beginning of the 21st century. The social polarisation is increasing between and within countries of the world.



Street vendor in Birchenough Bridge/Zimbabwe

(F. ZANDER)

Flexible employment practices were introduced into labour markets, thereby reducing social security protection for the majority of the workers. Informalisation of labour is a by-product of the reorganisation of corporate business policies towards relocating production to cheaper areas of the world. At present, one quarter of the global labour force works in the informal economy generating one third of global GDP. (Wick 2005) In the 90s, about 90% of all new jobs in Africa were created in the informal economy. (ILO 2002)

When the debt crisis started in the early 1980s, the World Bank and the IMF imposed "Structural Adjustment Programmes" (SAPs) on developing countries, requiring them to reduce government expenditures on employment and social programmes and open their markets to foreign investment. This led to increased labour and human rights violations and more widespread ecological devastation. International relocations and world-wide sourcing enabled TNCs to evade national labour regulations and profit from international competition between low-cost production sites. Therefore, as the influence of TNCs on the economic and social development of individual countries and the international community grew, social standards steadily declined.

Labour-intensive production has increasingly been shifted into "Export-Processing Zones" (EPZs) and the informal economy in developing and transition

countries. Next to electronics, the textile and garment/sportsshoe industries are the dominant sectors in the more than 3000 EPZs of 116 countries employing a total of 43 million workers. (Wick 2005) In many of these EPZs, national labour legislation is not applied. Further characteristics are the prohibition or obstruction of union activities and the predominance of female workers. The large majority of the workers in EPZs – amounting to 90% in some cases – are women between the age of 18 to 25. (Wick 2005)

This pattern of female employment in EPZs and in the informal economy is no coincidence. Companies gain several advantages by employing women. First, their wages are lower than for men (which also applies in highly industrialised countries). Secondly, young women who are often from rural areas and highly motivated to earn their living for the first time, have no opportunities to compare their working conditions with those of others. And thirdly, the double burden of unpaid family work and paid labour allows women hardly any opportunity to organise themselves in unions. And even if they were organised, they would still face the problem that many women's jobs are poorly paid or form part of the socially unprotected, informal economy in the very same labour-intensive industries where trade unions all over the world have lost ground for their organising activities during the past few decades.

Garment factory in Kenia



(CCC-NL)

3. Basic information on trade-related initiatives

3.1 Ethical consumption

In recent years, consumers in industrialised countries have shown considerably increased concern for the social and environmental conditions under which the goods they buy were produced.

“Fair trade sales in Europe grew in 2004 by an average of 30%, including 92% growth in the UK, 102% in France, 50% in Belgium and 60% in Italy, reaching worldwide sales of over EURO 600 million in 2004.” (IFAT 2005)

“Between 2002 and 2003, fair trade labelled sales across the world grew by 42.3%. In volume, the most important fair trade markets are the UK and Switzerland, together assuring a sales volume of 47,548 tonnes of fair trade labelled products.” (FLO website September 2005)

Yet, despite this remarkable increase, fair trade still constitutes an overall market share of less than 0.1% internationally.

To date, there are more than 700 fair trade labelled products. For instance, fair trade standards exist for coffee, tea, cocoa, sugar, honey, bananas, fresh fruit and vegetables, dried fruit, fruit juices, rice, wine, nuts and oilseeds, cut flowers, ornamental plants, cotton and sports balls.

Fair trade is being widely recognized as an important tool for sustainable development and poverty eradication. Fair trade also plays a role in raising awareness among consumers in industrialised countries about the injustice in global trade, as well as about the social responsibility of private and public actors.

More than 5 million people in 61 countries of Latin America, Africa and Asia benefit from fair trade relationships. They do not only receive a fair and stable

price for their products which provides them with a living wage and covers the cost of production. They are also engaged in a long-term partnership with the importers and benefit from decent working conditions, implying health and safety standards as well as participatory management mechanisms. Fair trade provides the advantage of pre-financing and capacity building to the producers, and it contributes to the protection of the environment. While most businesses do not internalise the costs of their social and environmental impacts, the fair trade movement believes that in order for trade to be sustainable, the full social, environmental and economic costs of goods and services must be taken into account.



The following example underlines the benefit which sales of fair trade products mean for producer organisations: In 2002, taking the world coffee market price for Arabica by the New York and for Robusta by the London stock exchange, compared with the fair trade minimum price and premium, the extra benefits for coffee farmers amounted to over 30 million US \$. (FLO website September 2005)

There are four international umbrella organisations of fair trade:

- a) the "Fair Trade Labelling Organisations International" (FLO) - 20 member organisations in 20 countries,
- b) the "International Fair Trade Association" (IFAT) - 270 member organisations in 60 countries,
- c) the "Network of European Wordshops" (NEWS) - 15 member organisations in 13 countries,
- d) the European Fair Trade Association" (EFTA), a network of the 11 largest importing organisations in 9 European countries.

Their informal joint working committee FINE aims at enabling these networks and their members to cooperate on strategic levels on issues affecting the future of the fair trade movement, such as advocacy and campaigning, standards and monitoring.

FINE defines fair trade as "a trading partnership, based on dialogue, transparency and respect, that seeks greater equity in international trade. It contributes to sustainable development by offering better trading conditions to, and securing the rights of, marginalized producers and workers – especially in the South". Fair trade organisations (backed by consumers) are engaged actively in supporting producers, awareness raising and in campaigning for changes in the rules and practice of conventional international trade.

FAIR TRADE SHOPPING IN GERMANY

A market research carried out by the institute EMNID in 2004 on behalf of the German consumer organisation "Verbraucher Initiative" showed that two thirds of German consumers are interested in buying fair trade products. When it comes to actually buying fair trade products, 25% of the interviewed persons stated that they have already bought them, while a further 25% bought them occasionally, and 2.9% on a regular basis.

An overall assessment of a study on global fair trade which was published in the year 2000 in Germany, stated that the concentration on small producers in developing countries is questionable, since industrial production is much more important for many of these societies and should be included into the system of preferential treatment. (Misereor/Brot für die Welt/Friedrich Ebert Stiftung 2000)

3.2 WTO and Workers' Rights

During the past decades, workers' rights in countries all over the world have been more and more affected by the international trading system under the guidance of GATT and WTO.



Garment factory near Jakarta/Indonesia

At present, the IMF, the World Bank and the WTO are the most important pillars of the system of multilateral governance in the world economy. The 148 member countries of the WTO seek further liberalisation of world trade. But the mandate of the WTO extends far beyond the trading of goods. The WTO also covers related areas such as services, investment, intellectual property rights, competition, legislation etc.. World trade is increasingly integrating the markets for goods, capital and labour. Decisions of the WTO directly or indirectly affect central aspects of the economic, structural, labour, and social policies of national governments. Despite its far-reaching national and international influence, however, the WTO is not subjected to any effective democratic control. National parliaments, unions and NGOs have only a very limited influence on the WTO.

Since 1995, when the Uruguay Round of trade negotiations gave birth to the foundation of the WTO, its liberalisation policy has benefited multinational corporations from industrialised countries to the detriment of workers' rights in most societies of the world. Since its inception, the WTO has been the target of campaigns and lobbying activities of the international labour, women and civil rights movement to improve the working and living conditions of peoples

around the world. Whereas at the beginning, this movement largely concentrated on the campaign to integrate a social clause into the framework of the WTO, it now embraces a whole range of demands going beyond the immediate link between trade and employment, such as democracy, debt relief, poverty eradication, environmental protection, etc.

Concerning trade agreements – be they multilateral or bilateral – the international trade union movement has been campaigning during the past years to link them to the core labour standards of the ILO. According to the ICFTU and the Global Unions, this link should be pursued and overseen by a special body of the WTO. However, to date, this demand has not materialised due to strong opposition from many governments in the WTO including some developing countries which consider it to be a protectionist tool in the hands of industrialised countries. This fear is shared by a variety of civil society groups questioning the overall policy and legitimacy of the WTO in view of its impact on global social degradation and rising inequalities.

WTO-related activities of the worldwide labour movement and civil society groups target the whole range of WTO agreements such as GATS, TRIPs, TRIMS as well as its governance policy and structure. Concerning the phase-out of the WTO Agreement on Textiles and Clothing (ATC) on 31 December 2004, international alliances of trade unions and NGOs such as the Clean Clothes Campaign appealed not only to multinational corporations, but also to national governments and the WTO, to protect workers of this globalised industry which were threatened by the effects of liberalisation. Millions of textile and garment workers in non-competitive countries are now faced with the danger of losing their jobs without alternatives, and without the protection of social safety nets. (Ferenschild/Wick 2004)

Ten years after the foundation of the WTO, its policy of opening up markets and privatisation has narrowed the power of national governments to secure labour and social rights of the people. The transformation of the WTO into a body to guarantee these rights will remain on the agenda of the labour movement and civil society groups in the foreseeable future.

3.3 International Framework Agreements

Since the middle of the 90s, global unions have developed company-related international agreements on social minimum standards as a new instrument of transnational corporate industrial relations in response to the challenges of globalisation. International Framework Agreements (IFAs) are also a union response to the proliferation of codes of conduct which have been introduced unilaterally by TNCs as part of their corporate social responsibility policies since the 90s. The ICFTU Basic Code of Labour Practice of 1997 represented an important benchmark for the negotiation of IFAs between global union federations (GUFs) and TNCs with the aim of establishing a form of social dialogue and industrial relations at global company level.

"A framework agreement is an agreement negotiated between a multinational company and an international trade union organisation such as a Global Union Federation GUF, formerly International Trade Secretariat) concerning the international activities of the company. Although an international code of conduct can be part of a framework agreement, the main purpose of a framework agreement is to establish an ongoing relationship between the multinational company and the international trade union organisation." (see chapter 8)



ALL FRAMEWORK AGREEMENTS					
International Framework Agreements concluded between Transnational Companies and Global Union Federations (GUF)					
Company	Employees*	Country	Sector	GUF	Year
Danone	100,000	France	Food Processing	IUF	1988
Accor	147,000	France	Hotels	IUF	1995
IKEA	70,000	Sweden	Furniture	IFBWW	1998
Statoil	16,000	Norway	Oil Industry	ICEM	1998
Faber-Castell	6,000	Germany	Office Material	IFBWW	1999
Freudenberg	27,500	Germany	Chemical Industry	ICEM	2000
Hochtief	37,000	Germany	Construction	IFBWW	2000
Carrefour	383,000	France	Retail Industry	UNI	2001
Chiquita	26,000	USA	Agriculture	IUF	2001
OTE Telecom	18,500	Greece	Telecommunication	UNI	2001
Skanska	79,000	Sweden	Construction	IFBWW	2001
Telefonica	161,500	Spain	Telecommunication	UNI	2001
Merloni	20,000	Italy	Metal Industry	IMF	2002
Endesa	13,600	Spain	Power Industry	ICEM	2002
Ballast Nedam	7,800	Netherlands	Construction	IFBWW	2002
Fonterra	20,000	New Zealand	Dairy Industry	IUF	2002
Volkswagen	325,000	Germany	Auto Industry	IMF	2002
Norske Skog	11,000	Norway	Paper	ICEM	2002
AngloGold	64,900	South Africa	Mining	ICEM	2002
DaimlerChrysler	372,500	Germany	Auto Industry	IMF	2002
Eni	70,000	Italy	Energy	ICEM	2002
Leoni	18,000	Germany	Electrical/Automotive	IMF	2003
ISS	280,000	Danmark	Cleaning & Maintenance	UNI	2003
GEA	14,000	Germany	Engineering	IMF	2003
SKF	39,000	Sweden	Ball Bearing	IMF	2003
Rheinmetall	25,950	Germany	Defence/Auto/Electron.	IMF	2003
H&M	40,000	Sweden	Retail	UNI	2004
Bosch	225,900	Germany	Automotive/Electronics	IMF	2004
Prym	4,000	Germany	Metal Manufacturing	IMF	2004
SCA	46,000	Sweden	Paper Industry	ICEM	2004
Lukoil	150,000	Russia	Energy/Oil	ICEM	2004
Renault	130,700	France	Auto Industry	IMF	2004
Impregilo	13,000	Italy	Construction	IFBWW	2004
Electricité de France (EDF)	167,000	France	Energy Sector	ICEM/PSI	2005
Rhodia	20,000	France	Chemical Industry	ICEM	2005
Veidekke	5,000	Norway	Construction	IFBWW	2005
BMW	106,000	Germany	Auto Industry	IMF	2005
EADS	110,000	Netherlands	Aerospace	IMF	2005
Röchling	8,000	Germany	Auto industry, plastics	IMF	2005

* The employee figures are mainly taken from the respective company's website. The overview shows the number of employees who are directly employed by a company. Most agreements have also effects on sub-contracting companies and suppliers. In these cases the number of people affected by the agreement is of course higher.

“Because the GUF have affiliates throughout all regions of the world and often in both home and host countries, they are the legitimate international voice of workers in their respective industries or economic sectors. An additional advantage of working through an GUF is that trade unions will be addressing specific situations while, at the same time, strengthening the international trade union movement.” (chapter 8)

Whereas IFAs existed in only nine companies in 2000, by the end of October 2004 IFAs had been concluded in 39 companies.

IFAs establish frameworks of principle and are not detailed collective agreements. They are not intended to compete with collective bargaining agreements at a national level. Instead, they aim at creating space for workers to organise and bargain.

All IFAs include the respect for the core labour standards, whereas some of them have been signed on other issues too, including training and education. Most IFAs do not deal with monitoring and verification, but rather are used to build organisations for workers so as to empower them to enforce workers rights themselves. However, in the wake of the IFA signed between IKEA and the IFBWW in 1998, a monitoring group was set up to ensure union involvement in the development of social standards at IKEA and of an internal management system.

Although an overall assessment of the impact of IFAs has not been made yet, it is already clear that some of them turned out to be useful instruments – irrespective of a number of deficits and obstacles. For instance the relationship between the management and the workers' representatives of Nestle in Europe improved considerably after the framework agreement had been concluded in 1996. As a result of the framework agreement between the Accor hotel group and the IUF the management of the company's hotels in the USA and Australia noticeably reduced their anti-union stand. The framework agreement between Del Monte and the IUF of 2000 led to banana workers in Guatemala getting back their jobs and being compensated for wage losses.

Some the framework agreements could only be concluded because of strong pressure from the unions accompanied by media activities. And these agreements undoubtedly will have to be followed up by a continuous process in which unions will have to show their power both locally and internationally.

In some industries, however, the presence of unions is greatly diminished or has never been strong, due partly to the restructuring of the world economy in recent years and partly historical deficiencies of the unions themselves, such as gender-biased organising practices. This applies to textile and garment industries all over the world, for instance. It is no coincidence, therefore, that most of the codes of conduct developed in the recent past originated in this sector.

3.4 World Works Councils and Global Union Networks

In the late 60s and 70s, global unions (then called “International Trade Secretariats”) established more than 50 World Company Councils within TNCs with the objective of harmonising wages and working conditions. The establishment of world company councils was considered to be an important step towards transnationally coordinated collective bargaining. (Müller/Rüb 2004). However, the world company councils failed to live up to their ambitions, and their actual function was reduced to an exchange of information. In a modified and simplified way, the strategy of the global unions survived and took the form of World Works Councils (WWCs) and Global Union Networks (GUNs) as well as informal networks of trade unions.

WORLD WORKS COUNCILS (WWCs)

Basing themselves on the model of European Works Councils (EWCs), WWCs can be defined as a “global forum for the exchange of information and dialogue between employee representatives and group management”. (Müller/Rüb 2004) As opposed to the legal framework in which EWCs operate, WWSCs function on a voluntary basis. There is no global-level regulation defining the procedure for the negotiations of WWCs. WWCs are based on a bilateral agreement between employees' representatives and group management and mostly comprise company-level lay employee representatives. The main objective of WWCs is to obtain information from the central management with the aim

of having workers' interests considered in transnational decision-making processes.

Presently, there are six WWCs: SKF (since 1995), Statoil (since 1998), Volkswagen (since 1998), Renault (since 2000), DaimlerChrysler (since 2002) and ENI (since 2002). (Müller/Rüb 2004) It is possible that further WWCs exist which are not based on formal agreements. In some TNCs such as Danone, EWC structures have been extended to include representatives of global unions.

In the recent past, the WWC at DaimlerChrysler succeeded in transcending its role as a pure information body. It was able to block an attempt by the group management to shift production to Germany and Brazil after a strike in the South African operations.

GLOBAL UNION NETWORKS (GUNS)

GUNs are company-level structures which were initiated unilaterally by global unions and their affiliates for specific companies to bring together trade union officials and lay representatives on a global level. Whereas WWCs mainly comprise company-level employee representatives, GUNs are genuine trade union structures and initiatives.

The GUNs aim at fostering the exchange of information, communication, coordination and cooperation among the network members. (Müller/Rüb 2004) In many cases, an additional goal is to establish a dialogue with management by encouraging management representatives to take part in network meetings. By gradually involving management, GUNs can be transformed into WWCs, such as in the case of the Swedish company SKF.

There are approximately 35 GUNs today. The global unions face the problem of lack of financial resources being the major impediment to both the quantitative and qualitative development of GUNs. (Müller/Rüb 2004)

There are also regional network structures of company-level employee representatives and unionists such as in the case of BASF which were set up in close cooperation between ICEM, the German Central Works Council at BASF and the German union IG BCE. In addition to the EWC which was set up in 1995,

the first regional structures were established for South America in 1999, and for the Asia-Pacific region in 2000. Although the regional structures are not based on an official agreement, representatives of central and regional management attend the network meetings. In 2002, management decided to bear the costs of network meetings also outside Europe.

It should be borne in mind that GUNs generally suffer from limited personal and financial resources hindering the social dynamic of networking and democratic participation.

3.5 Codes of conduct

THE PROLIFERATION OF CODES OF CONDUCT

Codes of conduct are booming. In view of this proliferation and public debates dating back to the early 1990s, the UN, the "Organisation for Economic Cooperation and Development" (OECD), the European Commission, the European Parliament, the ILO and the ICFTU have recently produced analyses, initiatives, codes or redrafts of codes. For instance, the UN "Global Compact" initiated by UN Secretary General Kofi Annan in 1999, the revised version of the "OECD Guidelines for Multinational Enterprises" dated June 2000, the ILO "Overview of global developments and Office activities concerning codes of conduct, social labelling and other private sector initiatives addressing labour issues" of November 1998 and the ICFTU Basic Code of Labour Practice of 1997 must be seen in this context.

According to World Bank estimates, there are 1,000 codes of conduct in existence today, developed by individual companies on a voluntary basis. (World Bank 2003a) To date, the most detailed analysis of codes of conduct was made by the OECD in 2001 taking into account a variety of criteria such as types of issuer, countries of origin, issue areas, etc. (OECD 2001b)

A brief look at the total number of existing codes of conduct in the OECD review shows that the largest share regarding industries relates to the textile and garment sector. This industry is highly internationalised and labour-intensive,

COMPOSITION OF CODES BY TYPE OF ISSUER

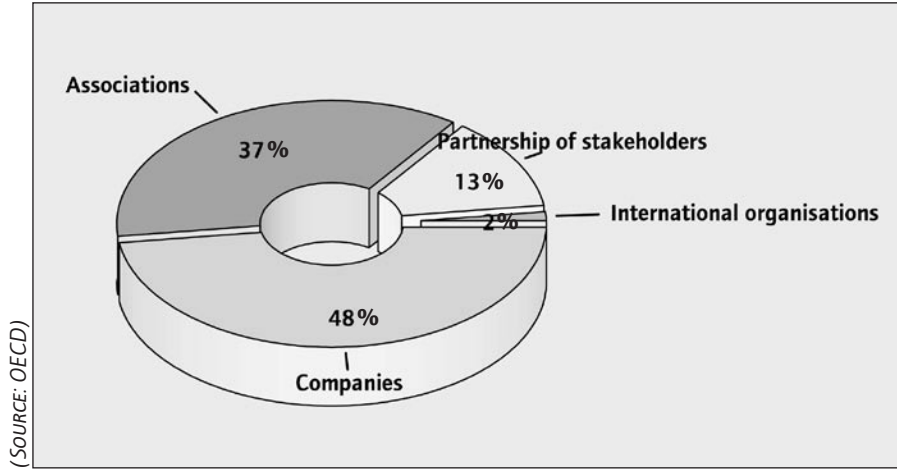

is located mainly in developing and Eastern European countries and operates a sophisticated sub-contracting system. During the past 30 years, the labour conditions of the majority of workers along the supply chain have deteriorated – through an increase of informal work in sweat shops and at home, through child labour and through an extension of “Export Processing Zones” to many parts of the world. The ILO study on “Labour practices in the footwear, leather, textiles and clothing industries”, published in October 2000, states that child labour, forced labour and discrimination against women are typical features of employment in this sector of industry.

Before proceeding to describe and analyse some prominent models of multi-stakeholder initiatives with emphasis on in the garment and sportsshoe sector, it will be necessary to provide a definition of codes of conduct, some basic information and a brief outline of their historical context.

DEFINITION AND BASIC INFORMATION

In a review dated May 2001, the OECD lists 246 codes of conduct, most of which were issued in the 1990s.

They are broadly defined as “commitments voluntarily made by companies, associations or other entities which put forth standards and principles for the conduct of business activities in the marketplace”.

Of the 246 codes of conduct, 118 were issued by individual companies, 92 by industry and trade associations, 32 by partnerships between stakeholders including unions and non-governmental organisations (NGOs) and 4 by inter-governmental organisations.

Of the 246 codes of conduct, 37 relate to the textile and clothing industry. Five of these were produced by coalitions of entities and 32 by individual companies – 25 of them from the USA. While 36 of the 37 codes related to the textile and clothing industry prohibit the use of child labour, fewer than 50% of them mention freedom of association. Of the company codes, 26 are addressed to suppliers and contractors and 23 do not mention monitoring systems.

ISSUE AREAS ADDRESSED BY THE CODES

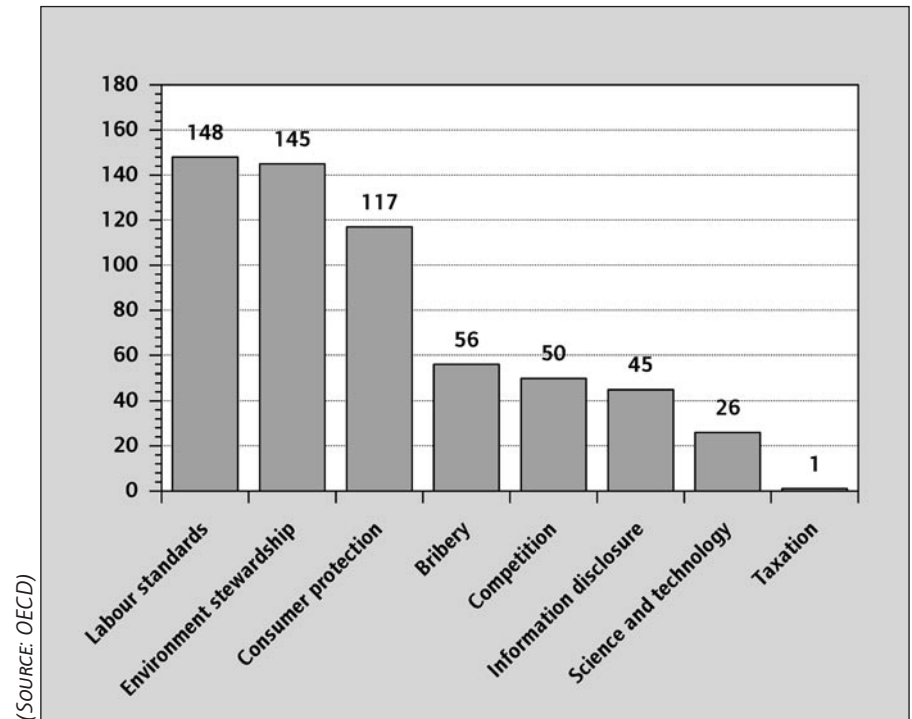

Of all codes, 66% mention some type of monitoring procedure. These are predominantly internal systems.

Of the 246 existing codes, 67 originated in the USA, 23 in the United Kingdom, 20 in Australia, 17 in Canada, 11 in Germany and 10 in Switzerland.

A HISTORICAL SUMMARY

The first codification of world-wide labour rights was achieved in 1919, when the newly founded "International Labour Organisation" adopted the first internationally binding convention. The ILO is composed of governments, unions and employers. By now, the ILO has adopted 185 conventions for the protection of workers' rights. In 1998, the ILO adopted the "Declaration on the Fundamental Principles and Rights at Work" which is binding for all ILO member countries. Due to their lack of sanctions, however, the ILO Conventions have too often remained ineffective in practice. Similar deficiencies have hampered attempts by the OECD, UNCTAD and the UN Commission on Transnational Corporations to make transnational companies (TNCs) liable for their social obligations in terms of international law. This problem is made all the more serious by the fact that, since the late 1970s, TNCs have increasingly evaded their social responsibilities and asserted more extensive rights as investors.

Since the early 1990s, the growing vacuum in applied labour legislation and the difficulties facing the union movement's attempts to grapple with the effects of neoliberal globalisation have caused labour-related NGOs to cooperate

COUNTRIES OF ORIGIN BY ISSUER OF CODE

	NUMBER OF CODES
Australia	20
Austria	4
Belgium	2
Canada	17
Czech Republic	4
Denmark	2
Finland	4
France	9
Germany	11
Greece	2
Italy	5
Japan	8
Korea	7
Luxembourg	1
Mexico	3
Netherlands	2
New Zealand	4
Norway	3
Spain	4
Sweden	6
Switzerland	10
United Kingdom	23
United States	67
Two or more countries	9
International	19

(SOURCE: OECD)

with unions in mobilising public opinion in industrialised countries against the socially and ecologically devastating policy of the TNCs. Electronic communications have helped to produce speedy headline reports in western media about labour and environmental rights violations, especially in the plants of TNC suppliers in developing countries. Global competition is so intense that any damage to the image of a TNC can easily turn into economic losses. To a certain extent, this explains the readiness of TNCs to talk to citizens' groups which use codes of conduct as a political instrument.

In the light of these dynamics, the definition of a conduct code as a "voluntary" commitment by a company seems questionable. In political, if not in purely legal terms, there is also an element of pressure behind this commitment.

CODES OF CONDUCT IN THE GARMENT/ SPORTSSHOE INDUSTRY

Since the new generation of codes of conduct have mainly concentrated on the textile and clothing industry, this development shall be described more in detail in the following.

In the early 1990s, the Dutch "Clean Clothes Campaign" (CCC) and the predecessors of the "Anti-Sweatshop Movement" in the USA informed the public about inhumane labour practices in plants of third-world suppliers to C&A and Levi's. These companies initially tried to deflate public pressure by talking to the protest groups and adopting internal conduct codes without making material concessions. Other NGOs and unions in other countries have had similar experiences with other companies. In many cases, the companies involved denied labour rights violations, criticised the information policy of the NGOs and threatened to take legal action. Some companies have also terminated business relations with suppliers in the developing countries, thereby increasing the social misery of the workers by causing them to lose their jobs. While keeping up their public pressure on TNCs, NGOs and unions therefore targeted international sourcing practices which expose most of the workers to social degradation. Once public opinion started producing economic effects – in the USA, for instance, many universities threatened to cancel licensee agreements with Nike or Reebok unless they agreed to sign codes of conduct – some companies gradually made more significant concessions. For instance, freedom of



Homeworkers in South Africa

association was added to the catalogue of social standards set by codes of conduct. In another example of company concessions, the first steps have been taken towards independent verification of conduct codes.

During the past few years, a number of multinational retailers and brands joined one of those multistakeholder initiatives analysed in this publication (see chapter 4). As a result of these efforts, working conditions in several supplier factories of member companies have started to improve. Yet, this progress is minimal with regard to the little share of companies involved in code verification initiatives globally, as well as compared to the totally inefficient majority of international company codes. (World Bank 2003a)

CODES OF CONDUCT ARE NO SUBSTITUTE FOR GOVERNMENTAL REGULATION

If conduct codes are treated as an alternative to governmental regulation rather than a complementary instrument, they pose the risk of promoting the priva-

tisation of the labour and social policies imposed by neoliberalism during the past 25 years. Unions and NGOs would grossly overestimate their capacities if they sought to achieve the verification of labour conditions at the global production sites of all suppliers to TNCs. Many multinational enterprises source their products from thousands of direct and indirect suppliers. Now that trade union bargaining power has been curtailed by the deregulation policy of governments and the subsequent "race to the bottom" of global social conditions, many expectations are being pinned to NGOs as a potential force to limit the influence of TNCs. However, the role of the NGOs should not be overestimated and the danger of their being misused must be seen quite clearly. Against the background of the previously described vacuum in regulated labour relations, they can hardly function as more than catalysts to encourage the (better) enforcement of existing laws or the creation of new legislation – either nationally or internationally.

CODES OF CONDUCT REQUIRE NEW SOCIAL ALLIANCES

However, this catalyst function is extraordinarily challenging. It requires new social alliances: between the trade union movement and women's organisations, for instance. In labour-intensive global industries such as the textile and garment industry, in the EPZs and in the informal economy, the predominance of women workers is obvious. While social conflicts have certainly intensified during the past few decades, codes of conduct can nevertheless be used as platforms to develop of a new type of labour organisation.

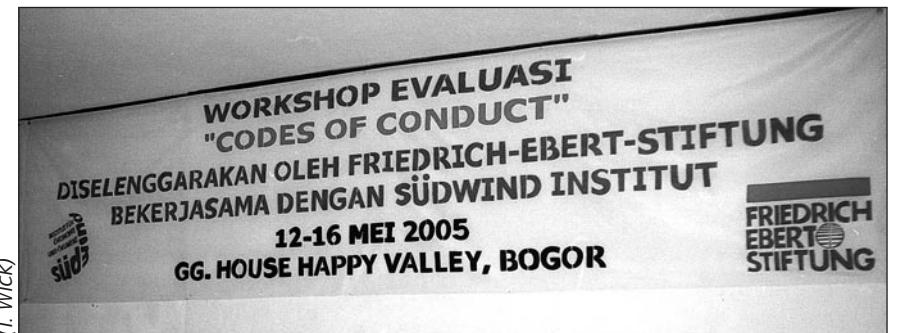

(I. Wrick)

4. Profiles of Multistakeholder Initiatives

The apparel and sportsshoe sector is the source of the greatest share of the conduct codes issued since the early 1990s.

Five currently prominent models of multistakeholder initiatives with emphasis on the garment/sportswear industry will be introduced and analysed below.

It should be borne in mind that these verification models are still rather new and are thus undergoing experimental processes. Therefore, not all of them provide definite answers to the topics discussed here.

4.1 Fair Wear Foundation (FWF)



GENERAL INFORMATION

In 1999, business associations, trade unions and NGOs launched the Fair Wear Foundation (FWF) in the Netherlands. The FWF is a multi-stakeholder organisation which aims to promote humane labour conditions in worldwide factories that produce garments for the Dutch market. The FWF Code of Conduct which is based on the model code of the ICFTU of 1997, adheres to the following principles: responsibility for the supply chain, internationally accepted labour standards and verification. As opposed to multistakeholder initiatives such as Social Accountability International, the FWF is not a certification body, but follows a pragmatic process approach. Its member companies continuously work towards acceptable labour conditions gradually. The FWF uses different instruments to achieve its aims: complaints procedures for employees, external factory audits, contacts with local organisations and audits of management systems. In countries or regions where FWF members buy their goods, the FWF builds networks of partner organisations composed of trade unions, employer organisations, non-governmental organisations and public bodies, and invites them to participate actively in FWF policy decisions.

So far, the FWF has been active in Bangladesh, China, India, Indonesia, Macedonia, Poland, Rumania, Turkey and Tunisia, and has published background studies on these countries with the exception of Bangladesh, Indonesia and Tunisia.

Currently, the FWF has 15 member companies:



The German company Hess Natur was the first company outside the Netherlands to become a member of the FWF (2005).

The Executive Board of the FWF comprises four categories of organisations, each with equal voting rights. In addition, there is an independent chair. The current composition is:

EXECUTIVE BOARD
Chair
<i>GERRIT YBEMA</i> , former State Secretary of Economic Affairs
Organisations representing garment suppliers
<i>HARRY VAN DALFSEN</i> , Chair Modint
<i>HAN BEKKE</i> , Substitute board member, General Director Modint
Organisations representing garment retailers
<i>JAN MEERMAN</i> , Chair Mitex
<i>JAN DIRK VAN DER ZEE</i> , Substitute board member, Managing Director Mitex
Trade unions
<i>W.W.M. WAGENMANS</i> , representative FNV Mondiaal
<i>ELLEN DEKKERS</i> , General Secretary FNV Bondgenoten
Substitute board member: vacancy
NGOs
<i>EVERT DE BOER</i> , Chair Clean Clothes Campaign
<i>ERIKA SPIL</i> , representative South-North Federation
<i>ERIC OOSTRIJK</i> , Substitute board member, Managing Director South-North Federation

The Advisory Committee of Experts supports both board and staff. This committee comprises experts from the same broad spectrum of organisations as the board (see following page).

SOCIAL STANDARDS

The FWF Code of Conduct is based on the model code of the ICFTU and refers to the following ILO conventions:

COMMITTEE OF EXPERTS
Organisations representing garment suppliers
<i>JEF WINTERMANS</i> , Managing Director Modint
Organisations representing garment retailers
<i>MARC OTTEN</i> , representative Mitex
vacancy FGHS
Trade unions
<i>ASTRID KAAG</i> , representative FNV Mondiaal
<i>ARNO DAHLMANS</i> , representative FNV Bondgenoten
NGOs
<i>FENNY ESHUIS</i> , representative Max Havelaar Foundation
<i>MARLIES FILBRI</i> , representative NOVIB
<i>INEKE ZELDENRUST</i> , representative Clean Clothes Campaign Netherlands
<i>CHRISTA DE BRUIN</i> , representative Clean Clothes Campaign Netherlands

- No forced labour
- No discrimination
- No child labour
- Freedom of association and the right to collective bargaining
- Payment of a living wage
- No excessive working hours
- A safe and healthy workplace
- A legally binding employment relationship

SCOPE OF APPLICATION

FWF member companies accept responsibility for labour conditions in their own company and their supply chains including suppliers and subcontractors.

MONITORING / VERIFICATION

Each year, FWF member companies must monitor the implementation of labour conditions in the entire supply chain based on the social standards of the FWF Code of Conduct. The FWF verifies whether member companies are doing so.

In the run-up to monitoring and verification, the FWF commissions a background study by a local organisation or researcher. This study includes an overview of local trade unions, employer's organisations and non-governmental organisations, with which FWF aims to co-operate, as well as a short analysis of the garment sector, labour relations and existing labour legislation of the country concerned.

The FWF member companies commit themselves to keeping a supplier register, performing audits and implementing corrective actions plans, training staff and updating documentation, as well as public reporting. During the first year of membership, a minimum of 40% of the supply base must be audited, 60% during the second year, and the entire supply base in the third year. Member companies can contract FWF trained audit teams for their factory audits. An audit team generally consists of an accountant, a health and safety expert and people who interview employees and the management. FWF has a detailed manual for use by audit teams.

The external verification takes place at two levels: The FWF verifies a) the implementation of the labour conditions, and b) the management system requirements. In principle, the FWF conducts external verification audits at 10% of each member company's supplier facilities every three years. However, in recent years, the external verification proved to be unnecessary since inspection teams for internal audits have already been trained and supervised by the FWF, and external audits would have been a duplication of efforts. At any rate, verification takes place by means of checking complaints procedures for workers and the accounts of the Dutch member company. Consultations with local organisations play a key role in the verification of the FWF.

In 2004, FWF member companies performed 24 audits in India, China, Macedonia and Poland.

In recent years, stable relationships have been established with partner organisations in a number of garment producing countries in which the FWF has been active. Concerning China where it is difficult to build up and maintain those relationships, the FWF agreed with social organisations in Hong Kong and the mainland to conduct a series of training workshops in supplier factories of member companies.

REPORTING / DISCLOSURE

Member companies publish annual reports on the compliance with the FWF standards and post them on their website. These reports reveal which brands they have been working under, the number of suppliers/producers and the countries, how many factories have been audited in each country, which violations of labour standards were identified, which improvements have been agreed on with the producer, and whether the improvements have been effective. Member companies keep a supplier register which is regularly updated and made known to the FWF.

In its annual report, the FWF publishes information about which verification activities have been carried out with which members, which violations of the agreements in the work plans have occurred and which improvements have been agreed on.

The year 2004 was the first in which FWF was fully operational. The latest annual report was published in May 2005. The FWF also publishes a newsletter three to four times a year and posts it on its homepage.

COMPLAINTS / APPEALS / CORRECTIVE ACTION

The FWF verification relies on an effective complaints mechanism of workers.

Members of FWF partner networks and other interested parties have the possibility to file complaints to the FWF which assesses whether or not it is related to the FWF Code of Conduct. Member companies are then responsible for deal-

ing with the complaint and initiating corrective action. All parties involved are informed regularly. The FWF is ultimately responsible for ensuring that the complaint is adequately being dealt with.

So far, the FWF has not received any complaints.

COSTS / FINANCING

In 2004, the FWF had an income of US \$ 494,460. This amount was – amongst others – composed of US \$ 152,520 from the “Social Fund Manufacturing”, of US \$ 209,100 from the “Social Fund Retail Trade”, of US \$ 55,350 from a subsidy of NOVIB (Oxfam Netherlands), of US \$ 20,910 from contributions of participating companies, and of US \$ 43,050 from reimbursements of audit costs. The “Social Fund Manufacturing” and the “Social Fund Retail Trade” are financial contributions to the FWF as a result of two collective labour agreements in the garment sector; it has been decided that whenever a collective bargaining agreement is reached, a contribution from employees is withheld and employers contribute the same amount.

Members pay annual fees to the FWF based on the level of the company's turnover and the number of garment suppliers, but the FWF does not publish specific amounts.

The other costs for a member company concerns the implementation of the management system requirements, monitoring of suppliers, and hiring local consultants to assist with implementation of the Fair Wear labour standards.

The FWF activities of the partner networks are paid for by the party who requests them, e.g. the FWF, a member company, or a supplier.

CURRENT DEVELOPMENTS / COMMENTS

The local partner networks in the garment producing countries, their establishment and involvement in the verification system, play a key role in the FWF system. This cooperation implies a rather slow progress of verification, but it

ensures local ownership and lays the ground for sustained improvements of labour conditions in the garment industry.

During the past years, the FWF has made the first steps towards becoming a European verification initiative. To that end, European stakeholders have been consulted, and generally there has been support for such an initiative. The first “Non-Dutch” member of the FWF has been the German company Hess Natur which joined the FWF at the beginning of 2005. This membership model is based on a German working group complementing the FWF activities.

In cooperation with four other multistakeholder initiatives and the Clean Clothes Campaign, the FWF takes part in the “Joint Initiative on Corporate Accountability and Workers’ Rights” (see chapter 4.6).

4.2 Social Accountability International (SAI)

GENERAL INFORMATION



In 1997, the Council on Economic Priorities (CEP), a U.S. corporate-responsibility research institute, proceeded to develop the “Social Accountability 8000” (SA8000) standard on the basis of experience gained with the ISO (=International Organisation for Standardisation) 9000 norm on quality management. CEP's aim was to establish a cross-industry standard for workplace conditions and a system of independent verification. In 1997, CEP founded the “Council on Economic Priorities Accreditation Agency” (CEPAA). The SA8000 standard was field-tested in five countries. In the summer of 2000, CEPAA was renamed “Social Accountability International” (SAI).



SAI convenes companies, government, trade unions, NGOs, socially responsible investors and consumers to promote understanding and implementation of SA8000 standards worldwide. SAI systems feature certification of compliance at the facility level and support for companies seeking to implement SA8000 standards in supply chains.

SA8000 ADVISORY BOARD MEMBERS

SAI's policy is to balance its Advisory Board members equally between business and non-business (non-governmental organizations, trade unions, socially responsible investors and government) members. SAI also seeks to have an international representation on the Advisory Board.

■ Affiliated with Non-Governmental Organizations, Trade Unions, Socially Responsible Investing and Government*:

DORIANNE BEYER/DAVID ZWIEBEL (alternate), National Child Labor Committee (USA)

JAN FURSTENBORG/CHRISTINE ASMUSSEN, Union, Network International (Switzerland)

ODED GRAJEW/HELIO MATTAR (alternate), Abrinq Foundation for Children's Rights (Brazil)

JOSEPH IAROCCI, CARE International

NEIL KEARNEY, International Textile, Garment & Leather Workers Federation (Belgium)

KAIMING LIU, Institute of Contemporary Observation (China)

ALICE TEPPER MARLIN, Social Accountability International (USA)

FRITS NAGEL, Dutch Consultant for Corporate Social Accountability (The Netherlands)

THE HONORABLE WILLIAM THOMPSON/KEN SYLVESTER (alternate), Office of the Comptroller, City of New York (USA)

MORTON WINSTON, Amnesty International (USA)

LYNDA YANZ, Maquila Solidarity Network (Canada)

■ Affiliated with Business*:

GIORGIO BERTINELLI/MARISA PARMIGIANI (alternate), Legacoop and Coop Italia (Italy)

SYLVAIN CUPERLIER, Dole Food Company (USA)

TOM DELUCA (CHAIR), Toys "R" Us (USA)

DURAI DURAISWAMY/ROBIN CORNELIUS (alternate), Prem Durai Exports (India) and Switcher SA (Switzerland)

PIETRO FOSCHI/ANDREW KIRKBY (alternate), Bureau Veritas Quality International Holding S.A. (United Kingdom)

AMY HALL, Eileen Fisher (USA)

DAN HENKLE/SEAN ANSETT (alternate), Gap Inc. (USA)

DIEP THANH KIET, WEC Saigon (Vietnam)

DR. JOHANNES MERCK/ACHIM LOHRIE (alternate), OTTO-Versand, (Germany)

DAVID McLAUGHLIN/GEORGE JAKSCH (alternate), Chiquita Brands International (USA)

*Affiliations are for identification only

SAI's governance structure consists of

- the Board of Directors whose 7 members are composed of the SAI President, 1 lawyer, 1 consultant, 2 businessmen, 2 NGO persons,
- an Advisory Board whose 22 members represent 11 companies, 2 trade unions, 7 NGOs, 1 consultant for corporate social accountability and 1 Office of the Comptroller/City of New York (see table).

The SA8000 standard is intended for manufacturers/suppliers, but retailers can also adhere to it. The SA8000 implementation options are as follows:

- Certification: Companies operating production facilities seek to have individual facilities certified.
- Corporate Involvement Program (CIP): Companies that focus on selling or that combine production and selling, become "SA8000 Explorers" or "SA8000 Signatories". The CIP includes training courses for managers, suppliers and workers, technical assistance for managing audits, and SAI-verified reports. SA8000 Signatories promote SA8000 certification in some or all of their supply chain facilities.

There are 10 SAI-accredited certification auditors so far: ALGI, BVQI, CISE, CSCC, DNV, Intertek, RINA, RWTUV, SGS-ICS, TÜV Rheinland Hong Kong.

As of March 31, 2005, a total of 655 facilities have been certified in terms of SA8000. From 44 countries represented, Italy, China, India and Brazil figure on top, and from 50 industries represented, the apparel/textile and transportation industries have the largest share.

As of July 2005, signatory members of the CIP are Four-D Mgmt Consulting, Avon Products, Charles Vögele, Cutter & Buck, Dole Food, Eileen Fisher, Otto Versand, Synergies Worldwide, Tex Line and Toys R Us.

SOCIAL STANDARDS

With reference to relevant ILO Conventions, the Universal Declaration of Human Rights, the UN Convention to Eliminate All Forms of Discrimination against Women, and the UN-Convention on the Rights of the Child, the

SA8000 standard spells out the following social accountability requirements:

- Freedom of association and the right to collective bargaining
- Prohibition of forced labour
- Prohibition of child labour
- Prohibition of discrimination
- Living wage / compensation including requirements for an established employment relationship
- Occupational safety and health
- Hours of work
- Disciplinary Practices

SCOPE OF APPLICATION

Over time, the SA8000 standard has been extended to include not only manufacturing industries, but also agriculture and extractive industries. As previously stated, the SA8000 certification of individual facilities is at the heart

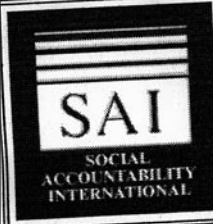

7th Annual SAI Conference
Beyond Compliance:
Innovative Strategies for Responsible Sourcing
&
Benefit Dinner
Leadership for a Better World

SAI's 7th Annual Conference, **Beyond Compliance: Innovative Strategies for Responsible Sourcing**, on **September 19, 2005** in New York City, will present practical solutions for corporations, governmental organizations, and trade unions – all who face challenges at the complex intersection of supply chain management and workplace accountability.

The convergence between supply chain management and managing an ethical workplace is vital for the survival and growth of companies in today's marketplace. At the Conference, you will gain hands-on tools, original ideas, and a strong network of contacts – and hear about inspired approaches from speakers that have faced the same challenges you face.

of the SAI system. Although there are provisions for and recommendations to subcontractors, these do not constitute an enforced or enforceable part of a company's agreement with SAI.

Retailers and brand companies are generally encouraged to assist suppliers and manufacturers to improve labour conditions.

MONITORING / VERIFICATION

Manufacturers and suppliers can be granted, by accredited certification bodies, the status of "applicants" for two years until they are verified by one of SAI's accredited Certification Auditors. The SA8000 Certificate must be renewed every three years.

Specially trained local audit teams will be briefed by local NGOs and unions, speak to managers and workers and check the records of the factories. The "Guidance Document for Social Accountability 8000" is the SAI manual which assists the accredited auditors in fulfilling this task. NGOs are also encouraged to undergo the process of becoming an accredited SAI auditor.

REPORTING / DISCLOSURE

The audit reports go to the companies and to SAI. Other parties can only receive them after having signed a confidentiality agreement with the company management and the audit company. However, the auditor will pass on the audit outcome to local unions and notify other parties involved in the pre-audit procedures.

The SAI issues a public list of certified facilities. It requires signatory companies to annually disclose the number of their certified suppliers and applicants for certification as well as the approximate number of all their suppliers.

COMPLAINTS AND APPEALS PROCESS / CORRECTIVE ACTION

Workers, unions and NGOs can file complaints and appeal against unsatisfactory audit results to the company involved, the certifying body or the accreditation agency.

According to the SA8000 Complaints and Appeals list published on the SAI website and last updated in 2002, there have been eight complaints between November 1999 and September 2002. Whereas two complaints are still pending, two SA8000 certifications of Chinese factories were withdrawn because of ongoing labour rights violations. In one complaint case, corrective actions in a facility in Kenya were implemented so that the certification remained. In two cases, the evidence showed that the complaints were groundless, and one complaint led to procedural recommendations.

COSTS / FINANCING

SAI is mainly financed by corporate membership fees, but recently, it also received grants from independent foundations and government agencies. For instance, on January 16th, 2001, SAI received US \$ 1 million from the US State Department. In December 2000 the Ford Foundation granted \$ 600,000 for the joint training project with the ITGLWF.

The annual fees paid by CIP participants vary by company sales:

Annual Fee Schedule (Charitable or non-profit organizations are entitled to a 20% discount on these fees.)		
Organization's annual revenue (US \$)	SAI explorer fee (US \$)	SAI signatory fee (US \$)
0–100,000,000	3,000	10,000
100,000,001–1,000,000,000	7,500	20,000
1,000,000,001–10,000,000,000	15,000	50,000
10,000,000,001 and up	25,000	65,000

The costs associated with preparing and conducting audits as well as with taking corrective actions are usually borne by the facility being certified, but can be shared with other parties, such as a customer that prefers SA8000 suppliers or has made certification to SA8000 a qualification for its business partners. In recent years, depending on the size of the facility, per diem audit costs amounted to a minimum of US \$ 13,500 and a maximum of US \$ 37,800 in 3 years excluding the costs for travel and translation.

CURRENT DEVELOPMENTS / COMMENTS

Concerning the social standards, and especially the emphasis on a "living wage" for workers, the SA8000 norm has been a progressive multi-party code since its inception.

Since the original publication of the SA8000 standard at the end of 1997, SAI has continuously reviewed the modalities of the "Guidance Document", corporate applications and membership, and the governance structure of SAI. At first, the SA8000 standard was criticised for failing to provide for adequate participation by unions and NGOs at decision-making levels and because of its very nature as a factory/farm rather than a brand certification system. In factory/farm certification systems, the responsibility for improving working conditions is placed on the producers in developing countries. A factory/farm applying for certification must bear the considerable costs of the process. On the other hand, in recent years, SAI has also extended its requirements on the financial commitment of its corporate CIP members and called on them to help suppliers implement the SA8000 standard, although the extent of this support remains unclear.

The relatively strong position of commercial auditing companies in code verification initiatives such as SAI has been met with initial international criticism, since these companies had no record in performing social audits in the past. For instance, the German SÜDWIND Institut filed a complaint against the SA8000 certification of the Indonesian factory PT. Pabrik Tekstil Kasrie in December 2001. This certification had been granted despite a case of dismissal of workers and union busting in this factory was still pending at the time. However, in recent years, improved auditor training courses, suppliers'

and workers' trainings as well as more detailed provisions for the involvement of trade unions and civil society groups in audits have contributed to counter-balance the strong position of auditors in the SAI system.

In 2001, SAI and the International Textile, Garment & Leather Workers' Federation started an education programme for workers in 12 developing countries. This programme covers the development of education materials and the conduct of workshops and training courses for up to 6000 workers in six Asian, three African and three Latin American countries.

SAI is part of the "Joint Initiative on Corporate Accountability and Workers' Rights" (JOIN) of five multistakeholder initiatives and the Clean Clothes Campaign which started to operate in 2003 (see chapter 4.6).

4.3 Ethical Trading Initiative (ETI)



GENERAL INFORMATION

The ETI in the United Kingdom was launched in January 1998 and formally established in October 1998. The ETI is an alliance of companies, NGOs and trade union organisations that is working to improve labour conditions in the supply chains in Britain. It has adopted the principle of continuous improvement and calls it- self a learning forum promoting good practice in implementing codes of conduct, sharing learning with mem- bers and the public, as well as measuring impact of imple- menting the ETI Base Code on the lives of workers. A sizeable grant from the British government helped to establish the ETI (see below "Costs/Financing").



The ETI uses various instruments: a) the ETI Base Code, which outlines the social standards and the implementation / verification principles; b) experimental and research projects; c) monitoring corporate performance; d) building capacity; e) other activities such as the " Joint Initiative on Corporate Accountability and Workers' Rights" .

The ETI members comprise 34 companies, 16 NGOs and 4 unions (see table).

Its Governing Board comprises 9 voting members. It is made up of equal representation from the three main categories of members, companies, trade union organisations and NGOs. The Board is directed by an independent chair. The government Department For International Development has an observer status.

The ETI is further governed by caucus groups - trade unions, NGOs and companies - as well as by workings groups on specific subjects such as " Impact Assessment" .

Experimental projects have been completed in South Africa, Zimbabwe, China, Costa Rica und India. Other projects are currently being carried out and planned in Sri Lanka, Kenya, United Kingdom, India, China and other countries. Each member company is expected to cooperate with trade union and NGO members of ETI in at least one experimental project.

SOCIAL STANDARDS

The ETI Base Code refers to the relevant ILO conventions. Freedom of association, working conditions, wage levels and child labour are regarded as key aspects.

The ETI Base Code alludes to the following ILO conventions:

- Rights to freedom of association and collective bargaining
- Prohibition of forced labour
- Prohibition of child labour
- Prohibition of discrimination
- Living wage
- Occupational safety and health
- Hours of work
- Regular employment relationship
- Prohibition of inhumane treatment.

MEMBERS OF THE ETHICAL TRADING INITIATIVE

Companies

Asda
 BBC Worldwide
 Bewley's
 Chiquita International Brands
 DCC Corporate Clothing
 Debenhams Retail
 Dewhirst Group
 Ethical Tea Partnership¹
 Flamingo Holdings
 Fyffes Group
 Gap Inc
 Greencell
 Inditex
 Levi Strauss & Co
 Lingarden
 Madison Hosiery
 Marks and Spencer
 Monsoon
 Mothercare
 New Look Retailers
 Next
 Pentland Group
 Peter Black Footwear and Accessories
 Premier Foods
 Quantum Clothing
 Ringtons
 Rohan Designs
 Rombouts GB
 Sainsbury's Supermarkets
 Somerfield Stores
 Tesco
 The Body Shop International
 The Boots Group
 The Co-operative group (CWS)
 Union Coffee Roasters
 WH Smith
 WIBEDCO²
 William Lamb Footwear
 World Flowers

Trade unions

International Confederation of Free Trade Unions
 International Textile, Garment and Leather Workers' Federation
 International Union of Foodworkers
 Trades Union Congress

Non-governmental organisations

Africa Now
 Anti-Slavery International
 CAFOD
 CARE International UK
 Central American Women's Network
 Christian Aid
 Fairtrade Foundation
 Home Workers Worldwide
 National Group on Homeworking
 Oxfam
 Quaker Peace and Social Witness
 Save the Children
 Traidcraft Exchange
 Twin Trading
 War on Want
 Women Working Worldwide

1. The Ethical Tea Partnership is an association of tea packers comprising Accord Services Ltd; Matthew Algie & Co; Brooke Bond Tea Co; Finlay Beverages; Gala Coffee & Tea; Imporient UK Ltd; Metropolitan Tea Company; DJ Miles & Co; Nambarrie Tea Co; Gold Crown Foods; Sara Lee Douwe Egberts; Keith Spicer; Taylors of Harrogate; Tetley GB; R Twining & Company; Unilever Plc/Nv; Williamson & Magor; Windmill Tea Co.
 2. The Windward Islands Banana Development and Exporting Company.

SCOPE OF APPLICATION

Although the "ETI Base Code Principles of Implementation" spell out the commitment of companies to communicate these principles "throughout the company and to their suppliers and sub-contractors (including closely associated self-employed staff)", the ETI does not require this commitment to be an "enforced and enforceable part of the agreement" between the company and the supplier.

MONITORING / VERIFICATION

According to the ETI Annual Report 2003/2004, different methods of monitoring and independent verification were tested or are currently being tested in the following experimental projects:

South Africa

The aim of the project (1998–2001) was to develop a multistakeholder methodology for inspecting labour practices in the wine industry of the Western Cape. The ETI members built relationships with wine producers, labour unions, NGOs and the Department of Labour in South Africa. The three rounds of inspections of six wine co-operatives and their farms were followed by improvements of labour conditions. As a result of the project, the South African stakeholders decided to establish a local monitoring initiative called "Wine Industry Ethical Trade Association" (WIETA).

Zimbabwe

The aim of this horticulture project (1998-2001) was to test commercial approaches to inspecting social conditions in this industry. A positive result of the cooperation between the ETI and the Horticultural Promotion Council of Zimbabwe was the creation of an independent monitoring body called "Agricultural Ethics Assurance Association of Zimbabwe". However, due to the overall tense political and social climate in Zimbabwe, this body has not been able to be very active during the past years.

China

An initial project was completed in May 2000, but ETI members expressed the need for an ongoing forum to share experiences and work collectively on common issues. A China Working Group established in March 2002 developed a basic guide to improving social conditions, including practical examples of how some members have attempted to create better working conditions. This guide is designed to be updated as experience expands. The China Working Group members also raised awareness of workplace safety and rights in China through experts' presentations and visits to southern China.

The current China project is supposed to be completed in 2007.

Costa Rica

This project (1999–2003) aimed at identifying workplace conditions in the banana industry and developing a methodology for improvements. It set out to use two approaches for social inspection: a standard commercial approach and a multistakeholder approach. After the completion of the first two commercial audits, corrective action plans covering improvements in contracts, health and safety procedures, and housing were implemented. Unfortunately, due to communication problems, the multistakeholder approach could not be tested.

Sri Lanka

This project started in 1999 and focuses on the garment industry. It aims at investigating ways of applying the provisions of the ETI Code by developing methods for identifying problems, formulating corrective action and assessing their impact. In August 2002, a multistakeholder working group was established in Colombo. In 2004, worker training courses were conducted for more than 4,000 workers.

India Child Labour

This project started in 2001 and was closed at the end of 2004. It aimed at assisting companies in identifying child labour in the garment and footwear industry in South India and devising means of dealing with it in a responsible manner. ETI delegations visited India in 2003 and met local stakeholders including government. A partner structure was established in Tamil Nadu

which visited London in 2004. However, agreement could not be reached on a number of issues in a common action plan. Efforts failed to recruit coordinators of the project both in India and in the UK.

Homeworkers

This project started in 2002 and aims at implementing and monitoring the ETI Code with homeworkers. A case study on homeworkers making Christmas crackers in the UK was closed. A further study on homeworkers in the embellishment industry in Northern India is currently being done. A tripartite local group has been established to plan forthcoming activities.

Small agricultural producers ("Smallholders")

This project started in 2002 and aims at improving labour conditions in small agricultural production sites in supply chains of ETI member companies. Kenya was selected as a target country of this project. A Kenya counterpart conducted research on the subject. Guidelines were drafted for ETI companies on how to apply and monitor the ETI Code provisions with smallholders. Member companies will later report back on the practical use of the Guidelines in their supply chains.

Temporary Labour Providers (Gangmasters)

This project started in 2002 and focuses on the working conditions of seasonal and migrant labour in the UK agricultural industry. The ETI has since coordinated a broad alliance of business and union organisations to work with government to improve the practices of temporary labour providers.

REPORTING

The ETI makes annual performance reports on verification practice and code implementation. Companies are expected to report progress to and through the ETI. At present, companies are not required to make their reports publicly available. However, most of them share them with the other ETI member companies, trade unions and NGOs.

COMPLAINTS / APPEALS / CORRECTIVE ACTION

Workers are provided with confidential means to report failure to observe the code and are otherwise protected in this respect.

Member companies are expected to negotiate and implement agreed schedules for corrective action with suppliers in a continuous improvement approach. In the event of continued serious breaches of the code, the ETI calls on companies to terminate the business relationship with the supplier concerned.

COSTS / FINANCING

The British Department for International Development (DFID) funded the work of the ETI during the 1998–2001 period, covering an earmarked grant of US \$ 850,000 for the work of the secretariat and 50% of the costs for the implementation of the pilot studies. Most of the remaining 50% of the project costs were paid by ETI member companies, with NGOs and unions providing further contributions.

A second three-year grant of the DFID for the period 2002–2004 amounted to US \$ 951,534.

Today, the ETI is funded by a combination of membership fees (currently comprising about 60% of the funding base), and a grant from the DFID (40% of funding). Membership fees vary by company sales, ranging from US \$ 3,600 to US \$ 54,100 (see table).

It is the local supplier who is expected to bear the costs of achieving compliance with the ETI code. However, ETI companies are exhorted to pay their suppliers adequate prices for their goods.

	Annual revenues (US \$)	FEES (US \$)
Level I	from 1,8 million to 180 million	3,600–10,800
Level II	from 180 million to 1,8 billion	13,200–22,500
Level III	over 1,8 billion	45,100–54,100

CURRENT DEVELOPMENTS / COMMENTS

The ETI being a learning forum and not a certification agency, has enjoyed considerable support from the British government and business since its inception. The "learning-by-doing" approach encouraged stakeholders to embark on experimental projects without running the risk of losing face. In fact, some of these projects turned out to be failures which are not considered to have been useless, but lessons from which stakeholders must learn.

The ETI experimental projects offer a broad variety of approaches to the implementation of international labour standards in global supply chains of transnational companies involving commercial auditing and various forms of multi-stakeholder verification. In some instances, progress consisted in building bridges between stakeholders, meanwhile in others it went as far as establishing local inspection bodies and contacts to local governments as well as improving labour conditions.

A detailed assessment of the advantages and disadvantages of the different ETI approaches to monitoring and verification is currently being made. The ETI commissioned a research on "Impact Assessment" whose purpose is to find out what impact implementation of the ETI Code is having on the lives of workers and their communities in supply chains of member companies, and to identify how this impact can be improved. This research focuses on the garment, footwear and food industry in India, Vietnam, South Africa, Costa Rica and China, and is supposed to be completed at the end of 2005.

Corresponding to its nature as a learning forum, the ETI has also intensified efforts to strengthen capacity-building in supplier countries and to develop a training programme to improve the skills of ETI corporate members, suppliers, unions and NGOs in implementing the ETI Code.

Next to members' roundtables and seminars, the ETI has also organised important code-related international conferences during the past years, such as a conference on the phase-out of the Agreement on Textiles and Clothing of the WTO in 2004.

The ETI is part of the "Joint Initiative on Corporate Accountability and Workers' Rights" of five multistakeholder initiatives and the Clean Clothes Campaign (see chapter 4.6).

4.4 Fair Labor Association (FLA)

GENERAL INFORMATION



The Fair Labor Association (FLA) was founded in November 1998 on the basis of the Apparel Industry Partnership (AIP), which had been initiated by the White House in August 1996 to address labour rights standards in the US and world-wide apparel industries. The aim of the FLA is to improve working conditions in factories in the garment and sportsshoe sector (and other industrial sectors touched by university licensee agreements) in the USA and abroad.

When the FLA was founded, the Union of Needletrades, Industrial and Textile Employees (UNITE) and Center on Corporate Responsibility (ICCR), all of which had participated in the AIP coalition of companies, unions, NGOs and universities, refused to join the new association. They complained that its social standards and verification principles contained serious flaws.



FAIR LABOR ASSOCIATION

NGOs like the Interfaith Responsibility (ICCR), all of in the AIP coalition of companies and universities, refused to join the new association. They complained that its social standards and verification principles contained serious flaws.

In April 2002, the FLA made important changes in its programme and monitoring procedures with the aim of increasing its transparency, independence, and scope. It agreed to add two new categories of participation – participating agents and suppliers – to its existing categories of companies and college/university licensees. This decision, however, was not meant to change the basic orientation of brand accreditation of the FLA.

To date, the FLA comprises 16 companies (see table), 191 colleges/universities and 33 NGOs such as the Lawyers Committee for Human Rights, the National Consumers League, as well as the National Council of Churches.

The Board of Directors is composed of representatives of 6 companies, 6 NGOs, 3 universities as well as the chair (see table).

The FLA accredited the following 12 monitors to perform the work of independent external monitoring: A & L Group, Cal Safety Compliance Corporation,

PARTICIPATING COMPANIES AND LICENSEES

These companies produce in more than 2500 factories in 62 countries, with sales totaling \$30 billion:

adidas-Salomon: All adidas-Salomon footwear, apparel and equipment

Asics: Asics footwear

Eddie Bauer: Eddie Bauer apparel

GEAR for Sports: GEAR for Sports and Champion Custom Products

Gildan Activewear

Liz Claiborne, Inc.: Liz Claiborne, Dana Buchman, Villager, Emma James, Russ, Crazy Horse - Men's and Women's, First Issue, Axxess, Sigrid Olsen, Claiborne (Men's), Elisabeth - Retail

New Era Cap

Nike: All Nike footwear, apparel and equipment

Nordstrom: Nordstrom private label apparel

Outdoor Cap

Patagonia: All products

Phillips-Van Heusen: Van Heusen brand, all Van Heusen apparel

Puma: All Puma branded goods, including licensees.

Reebok: All Reebok footwear and apparel

Top of the World

Zephyr Graf-X: All Zephyr Graf-X products

Cotecna Inspections, COVERCO, Bureau Veritas, Global Standards/Toan Tin, Grupo de Monitoreo Independiente de El Salvador, Kenan Institute Asia (Thailand), LIFT-Standards (Bangladesh), Phulki, SGS, T-Group Solutions.

FAIR LABOR ASSOCIATION BOARD OF DIRECTORS

Chairperson:

ADELE SIMMONS, Chicago Metropolis 2020

Company representatives:

ELIZABETH BORRELLI, Eddie Bauer

DOUG CAHN, Reebok

ART HEFFNER, Phillips Van-Heusen

REINER HENGSTMANN, Puma

GREGG NEBEL, adidas-Salomon

LINDA PEFFER, Nordstrom

NGO representatives:

MARSHA DICKSON, Educators for Socially Responsible Apparel Business

LINDA GOLODNER, National Consumers League

PHARIS HARVEY, Former Director of International Labor Rights Fund

MICHAEL POSNER, Human Rights First
(formerly Lawyers Committee for Human Rights)

JAMES SILK, ORVILLE H. SCHELL, Jr. Center for International Human Rights,
Yale Law School

One NGO seat currently vacant

University representatives:

ROBERT DURKEE, Princeton University

CAROL KAESEBIER, University of Notre Dame

ELIZABETH KENNEDY, University of Southern California

Ex Officio Board Members:

RICHARD LUCAS, Esq., Arnold&Porter LLP

LARRY MANN, University of Illinois

RICK VAN BRIMMER, The Ohio State University

SOCIAL STANDARDS

The FLA Workplace Code of Conduct addresses the following key issues:

- Prohibition of forced labour
- Prohibition of child labour (age limit is 15 years or 14 where the national law allows)
- Prohibition of harassment or abuse
- Prohibition of discrimination on the basis of gender, race, religion etc.
- Provision of a safe and healthy working environment
- Respect of freedom of association and collective bargaining
- Payment of wages and benefits – at least the legally mandated minimum wages and benefits
- Hours of work: Except in extraordinary business circumstances the hours of work shall not exceed 48 hours per week and 12 hours overtime, or the legally mandated hours per week plus 12 hours overtime
- Overtime compensation should follow legal prescription or – where such a law does not exist – should be at a rate at least equal to the regular hour compensation rate.

SCOPE OF APPLICATION

The FLA Code applies to all facilities of the company itself and those of the suppliers, contractors and licensees with the exception of minimal (“De Minimis”) facilities. The latter are those with which a company contracts production for only six months or less during a 24-month period, or with which the company accounts for only 10% or less of the annual production of such facility. In any event, these minimal facilities shall not constitute more than 15% of all production facilities of a company.

MONITORING AND VERIFICATION

According to the FLA Monitoring Program, participating companies agree to internal and independent external monitoring as well as remediation in order to promote compliance with the provisions of the FLA Charter. FLA monitoring takes place in the form of unannounced visits.

Internal company monitoring must cover 50% of all applicable facilities in the first year and all of them in the second year. In the independent external monitoring programme, the FLA staff will conduct annual audits of each company's compliance records and programmes and make field visits. Using a risk assessment methodology, it selects the facilities on a random sample basis to be monitored, and contracts with accredited monitors to conduct the audits, all of which are unannounced. At the end of 2002, the FLA lowered the percentage of externally-monitored facilities to 5% (10% in the initial membership period). The FLA verifies and vouches for the remediation process.

After two-three years of reaching satisfactory results of verification and accountability, the FLA accredits member companies' compliance programmes which must be reviewed every two years.

Labour and/or human rights organisations are encouraged to undergo the accreditation training process.

In August 2004, the FLA published its Year Two Annual Public Report on independent external monitoring. According to this report, the FLA conducted independent external monitoring visits to 110 facilities in 20 countries in the year 2003. The number of facilities represents approximately 5% of each company's applicable factory base in high-risk regions. During the factories visits by FLA-accredited monitors, problems were found such as the breaking of safety requirements, inadequate benefits and overtime payments. The report also identified the failure of employers to allow the forming of unions, and stated that all the factories surveyed were in non-compliance with that particular standard. Another point highlighted was the difficulty of promoting standards within international supply chains where a single brand will subcontract to a large number of factories globally.

REPORTING / DISCLOSURE

All internal and external monitoring reports will be provided in full to the FLA staff. The FLA issues annual public reports on the global compliance record of each of its participating companies. In April 2002, the FLA decided to disclose on its website, information related to monitored and independently-verified factories. This information includes the name of the participating company using the factory; the country/region of the factory; the product and size of the facility; the name of the monitor; the findings of non-compliance; the status of remediation.

The companies must provide a complete list of its applicable facilities to the FLA. All FLA schools with licensing programmes have policies that require the public disclosure of factory locations where their licensed products are made.

COMPLAINTS / APPEALS / CORRECTIVE ACTION

Third-party complaints – whether anonymous or public – can be directed to the FLA. There is also a confidential complaints mechanism to the brand company. The complaints must contain reliable, specific and verifiable evidence of information on a case of non-compliance with the Code provisions. The FLA provides for a subsequent process of remediation, after which the third party will be informed of the results.

During the past years, the FLA has received a number of third-party complaints from countries such as El Salvador, Pakistan, Dominican Republic, Guatemala, Indonesia, Honduras and Sri Lanka. For instance, in April 2002, the FLA published a report following a complaint against union rights violations at the factory BJ&B in the Dominican Republic. The FLA took up the case in close cooperation with the Worker Rights Consortium. In the framework of remedial steps, the majority of the retrenched workers were reinstated. In 2003, the FLA successfully intervened against anti-union activities in a Sri Lanka facility contracted by Nike. Each of the complaint cases referred to in the FLA Report 2004, relates to the violation of freedom of association.

COSTS / FINANCING

The FLA budget consists of contributions from member companies as well as from universities and their licensees (formerly also from government and foundations). Member companies pay dues at a minimum of US \$ 5,000 depending on their annual revenues. University dues consist of 1% of licensing revenues – ranging from a minimum of US \$ 100 and a maximum of US \$ 50,000.

The FLA has established the subsidiary LLC to cover the costs of independent external monitoring. Each participating company pays assessments at regular intervals into the LLC.

Each participating company shall bear all costs, “within reasonable and expected limits”, of any verification visits in connection with remediation measures.

CURRENT DEVELOPMENTS / COMMENTS

The sweeping reforms in the monitoring / verification system and the transparency policy adopted by the FLA in April 2002, opened a new chapter in the history of the FLA. Since then, the former criticism concerning the lack of union representation in the governing structure of the FLA has also been weakened due to its mediation in union conflicts in supplier factories of member companies. In fact, the majority of third-party complaints filed to the FLA to date, were related to freedom of association.

The FLA has initiated a series of special projects complementing the regular compliance programme, such as the “Hours of Work” Project in China, or the “Central America Project” whose subject is to develop a strategy against the blacklisting of unionists and other anti-union activities in the maquiladora industry of the region. In 2003, the FLA invited participants from all over the world to discuss the topic of “Living Wages” at a conference in Washington. These special projects fulfil the function of testing and innovating strategies to improve FLA code compliance.

The FLA takes part in the “Joint Initiative on Corporate Accountability and Workers’ Rights” (see chapter 4.6).

4.5 Worker Rights Consortium (WRC)

GENERAL INFORMATION



The Worker Rights Consortium (WRC) was founded on 7 April 2000 in New York on the initiative of “United Students Against Sweatshops” (USAS).

The WRC goal is to improve labour conditions in the sportswear supplier factories of companies producing goods under licence for US universities (Nike,

MEMBERS OF THE WRC GOVERNING BOARD

Representatives of the University Caucus

JIM BRUDNEY (Board Secretary), Ohio State University

MARCELLA DAVID, University of Iowa

JOHN “JAY” MARANO, Carnegie Mellon University

DOUGLAS SHAW, Georgetown University

JIM WILKERSON, Duke University

Independent Labor Rights Experts

Representing the WRC Advisory Council

JILL ESBENSHADE (Board Treasurer), Assistant Professor of Sociology, San Diego State University

MARK BARENBERG, Professor of Law, Columbia Law School

KATIE QUAN, Director, John F. Henning Center for International Labor Relations, University of California

THEA LEE, Chief International Economist, AFL-CIO

ALEJANDRA DOMENZAIN, Associate Director, Sweatshop Watch

Representatives of United Students Against Sweatshops

MARY NAGLE (Board Chairperson), Georgetown University

KIRSTIN JACKSON, University of California, Berkeley

JENNIFER CHIEN, Duke University

LIANA DALTON, University of Wisconsin-Madison

MARK IOZZI, Western Washington University

adidas-Salomon, Reebok etc.). The WRC supports and verifies licensee compliance with the codes of conduct for apparel manufacturers which US colleges and universities have developed in recent years to ensure that the licensed goods sold on their campuses are produced under humane working conditions. The WRC exhorts universities to enforce contract provisions requiring licensee companies to respect basic labour standards. The WRC is not a certification agency.

MEMBERS OF THE WRC ADVISORY COUNCIL

RICH APPELBAUM – Professor; Director, Institute for Social, Behavioral, and Economic Research (ISBER); University of California Santa Barbara

JEFF BALLINGER – Director, Press for Change

MARK BARENBERG – Professor of Law, Columbia University Law School

NIKKI F. BAS – Program Coordinator, Sweatshop Watch

ELAINE BERNARD – Director of Trade Union Program, Harvard University

EDNA BONACICH – Professor of Sociology, University of California Riverside

LINDA CHAVEZ-THOMPSON – Executive Vice President, AFL – CIO

GINNY COUGHLIN – Union of Needletrades, Industrial, and Textile Employees (UNITE)

REVEREND DAVID DYSON – People of Faith Network

JILL ESBENSHADE – San Diego State University

HOMERO FUENTES – Commission for the Verification of Corporate Codes of Conduct (COVERCO), Guatemala

GIRLIE GUZMAN – Asian Coordinator, Brotherhood of Asian Trade Unions

BEN HENSLER – International Affairs Department, AFL – CIO

GEORGE MILLER – U.S. Representative (D, California)

PEDRO ORTEGA – General Secretary, Federation of Apparel Leather and Textile Workers, Nicaragua

MARITZAH PAREDES – Collective of Honduran Women (CODEMUH)

EBRAHIM PATEL – Southern African Clothing and Textile Workers Union (SACTWO)

KATE PFORDRESHER – People of Faith Network

KATIE QUAN – Director, John F. Henning Center for International Labor Relations, University of California – Berkeley

CAROLINA QUINTEROS – Directora, Grupo de Monitoreo Independiente de El Salvador (GMIES), El Salvador

MONINA WONG – Labor Rights in China, Hong Kong Christian Industrial Committee

JUNYA LEK YIMPRASERT – Thai Labour Campaign, Thailand

Next to factory investigation and remediation, the WRC activities also consist of running a Worker Complaint System and a factory database, as well as carrying out research.

The WRC Governing Board consists of 15 members: five representatives each of a) college and university administrations, b) USAS, c) the WRC Advisory Council.

The WRC Advisory Council is composed of labour and human rights experts from the USA, Canada and international sportswear producer countries.

As of June 2005, a total of 143 colleges and universities in the USA had joined the WRC.

SOCIAL STANDARDS

The code of conduct developed by the WRC in 1999 is not compulsory for member universities, but they are required to include the following social standards in all other codes:

- Freedom of association – Right to collective bargaining
- Living wages
- A working week of not more than 48 hours
- Overtime compensation according to national law or at least 50% above the normal rate
- Prohibition of child labour
- Prohibition of forced labour
- Occupational safety and health
- Prohibition of discrimination
- Prohibition of harassment or abuse
- Women's rights.

SCOPE OF APPLICATION

The licensee company must present an affidavit declaring that all facilities producing goods under the licensing agreement, including those run by contractors and subcontractors, comply with the code of conduct provisions.

MONITORING / VERIFICATION

As part of the licensing agreement, the universities require licensee companies to ensure implementation and internal monitoring of the code of conduct and render full public disclosure of all production facilities for independent verification. Independent verification by the WRC Agency takes the form of spot investigations taking into account the information produced by the self-reporting and full-public-disclosure commitments of the companies. The WRC Agency operates independently of university licensing offices and industry representatives.

WRC goals do not include the establishment of a comprehensive independent verification regime nor the certification of companies.

Independent verification on a spot-check basis during unannounced visits relies on stable relationships with workers in apparel-producing countries. The WRC has continuously expanded its network of labour organisations in many countries and regions of the world during the past years.

To date, the WRC has conducted a total of 13 investigations into labour rights violations in supplier factories of collegiate licensees in 8 countries, 4 of them in Indonesia alone. Most of these investigations consist of extensive preliminary reports highlighting the details of labour abuses and recommending remediation, as well as of final reports taking stock of remedial action after several months. In some cases, negotiations led to memorandums of understanding between the conflicting parties. Except in one factory, all investigations resulted in a number of improvements of labour conditions. Yet, an assessment of the longer standing impact of WRC investigations has still to be made.

Here is a brief introduction into the WRC investigations since 2001:

Kukdong International / Mexico

In 2001, workers at the Nike and Reebok contractor factory Kukdong in Mexico complained about various forms of union repression at this factory. As a follow-up to the WRC investigation and large-scale campaigning in many US campuses, the independent union was accepted by the management.

New Era / New York

In 2001, the WRC undertook investigations into violations of occupational health and safety rights at the New Era Cap factory in Derby, New York. They resulted in a series of corrective actions.

Dada / Indonesia

In 2002, workers at this supplier factory of adidas-Salomon in Indonesia complained regarding violations of occupational health and safety standards, working hours and union rights. In the course of a few months, at least some of these violations had been remediated.

Primo / El Salvador

In 2003, the WRC conducted investigations into acts of union repression at this supplier factory of Land's End in El Salvador. Unfortunately, Land's End refused to cooperate not only with the WRC, but also with the FLA, both of which had received complaints from workers of this factory.

Dae Joo Leports / Indonesia

In 2003, the WRC initiated investigations into violations of union rights at this supplier factory of adidas-Salomon in the export-processing zone KBN north of Jakarta. In the aftermath of these investigations, a number of remedial actions were taken.

Kolon Langgeng / Indonesia

In 2003, workers at this supplier factory of Nike in the export-processing zone

filed a complaint regarding wages, overtime and occupational health and safety hazards. The WRC investigations led to some improvements of working conditions.

Tarrant Ajalpan / Mexico

In 2003, the WRC conducted investigations into violations of union rights at this supplier factory of Levi's and Hilfinger in Mexico. Some remedial steps were taken in the aftermath of the WRC findings and recommendations.

Rebound and VF India / India

In 2003, the WRC released a report on these two factories which are suppliers of the VF Corporation. Women workers had lodged complaints concerning sexual harassment and abuse by supervisors and managers. As a follow-up to the WRC investigations, workers confirmed a decrease of incidents of harassment, but on the other hand an ongoing overall insecure working environment.

Panarub / Indonesia

In 2004, workers at this supplier factory of Adidas-Salomon filed a complaint to the WRC concerning acts of union repression. As a follow-up to the WRC findings and recommendations, all retrenched workers were reemployed and several other union rights were recognized by the management.

Gildan Activewear / Honduras

In 2004, workers at the El Progreso factory in Honduras, a facility of Gildan Activewear, complained about acts of union repression. In January 2005, the WRC successfully concluded an agreement on remediation with Gildan Activewear. The WRC and the FLA joined efforts to solve the problems at this factory.

Lian Thai / Thailand

In 2004, workers at this supplier factory of Nike, Puma and Next complained about union repression, occupational health and safety hazards and labour rights violations of homeworkers. In the meantime, a number of first remedial steps have been taken.

Unique Garments / Swaziland

In 2004, the WRC undertook investigations into anti-union activities and the abuse of contract workers at this supplier factory of Reebok. To date, some of the WRC recommendations have been implemented.

Far East and First Apparel / Thailand

In February 2005, the WRC published a status report on the follow-up to its findings and recommendations concerning the violations of union rights and occupational health and safety standards at this supplier factory of the GAP and Levi's in Thailand. According to this report, some of the recommended remedial steps have been taken in recent months.

REPORTING

A licensee company's failure to report, or its reporting of false information, constitutes grounds for a range of sanctions, possibly including termination of the licensing agreement. A company's acceptance of the WRC's full public disclosure requirement means that the WRC will make its reports available to the general public and to worker-allied groups in producing regions.

The WRC updates its factory list quarterly. However, it cannot guarantee the accuracy or completeness of the information.

COMPLAINTS / APPEALS / CORRECTIVE ACTION

The WRC Agency is made responsible for receiving and verifying workers' complaints regarding abuses and violations of the WRC code or relevant university codes. The WRC cooperates closely with worker-allied organisations in verifying these complaints and taking subsequent corrective action.

COSTS / FINANCING

About 40% of the WRC funds derive from a share of the revenues obtained by colleges and universities from licensing agreements and by general contributions. Those colleges and universities with licensing programmes contribute 1% of their licensing revenues, or a minimum of US \$ 1,000 and a maximum of US \$ 50,000. Those without licensing programmes pay US \$ 1,000.

Grants from philanthropic foundations like the Rockefeller Foundation, the Arca Foundation or the New World Foundation, as well as from the federal government, make up about 60% of the WRC funds.

The licensee company must foot the bill for implementing and monitoring the code provisions.

CURRENT DEVELOPMENTS / COMMENTS

The WRC uses the licensing agreement applied by US colleges and universities as a lever to enforce labour standards. Since the sale of licensed goods at US colleges and universities is a major cost factor for licensees like Nike, adidas-Salomon or Reebok, these agreements represent a financial tool which the WRC can wield directly to achieve its aims.

The initial rivalry between the FLA and the WRC for the allegiance of US colleges and universities has decreased in recent years. There were several cases of fruitful cooperation between the WRC and the FLA, like for instance in dealing with complaints from the factories BJ&B in the Dominican Republic and the follow-up to the WRC investigations at the New Era factory in Derby. These steps of cooperation also result from several US schools being members of both, the FLA and the WRC.

As stated above, the WRC strategy consists of concentrating on a selection of a few complaint cases, and does not pretend to globally verify the ethical sourcing practices of collegiate licensees. The clear advantage of this strategy is the detailed evidence and follow-up procedure going hand in hand with an active

involvement of local stakeholders in production countries and international buyers. These efforts have by and large resulted in improvements of the workers concerned. The WRC has also tried to sustain these efforts by conducting trainings for workers at factories to inform them of their rights under collegiate codes of conduct. On the other hand, the limitations of the WRC strategy are also obvious. The considerable resources required for selected case studies do not allow to generalize their results.

Indonesian worker in the sportshoe factory PT. Panarub



(B. KÜHL)



4.6 Overview and Comparison / Joint Initiative

OVERVIEW OF MAIN FEATURES OF FWF, SAI, ETI, FLA, WRC

	FWF	SAI		ETI	FLA	WRC
INITIATIVE/ YEAR OF FOUNDATION	Dutch CCC and FNV 1999.	US-American consumer Organisation CEP 1997.		Various NGOs 1998.	Clinton Administration 1996.	US-American students' organisation USAS 2000.
AIMS AND OBJECTIVES	Improvement of labour conditions in the world-wide garment factories producing for the Dutch market.	Improvement of labour conditions in all industries.		Improvement of labour conditions in the world-wide garment and food industry and in horticulture.	Improvement of labour conditions in the world-wide garment industry and all industries producing under license for US universities.	Improvement of labour conditions in the world-wide garment industry producing under license for US universities.
METHODS/ INSTRUMENTS	<ul style="list-style-type: none"> a) Code of conduct based on the model code of the ICFTU of 1997 b) Audit of the management system c) Complaints procedure for employees d) Verification e) Cooperation with local partner organisations. 	<ul style="list-style-type: none"> SA8000 implementation by means of a) Certification: Companies operating production facilities seek to have individual facilities certified. b) The Corporate Involvement Program (CIP) for retailers/brands includes training courses and technical assistance for suppliers. c) Worker education programme in cooperation with ITGLWF. 		<ul style="list-style-type: none"> a) Member companies committed to implementation, monitoring and verification of ETI Base Code, b) Experimental and research projects, c) Monitoring corporate performance, d) Building capacity/ training courses for stakeholders in production countries. 	<ul style="list-style-type: none"> a) Workplace Code of Conduct – independent verification and accreditation of participating companies/ licensees, b) Special projects on important topics. 	<ul style="list-style-type: none"> a) Code of Conduct – no certification of licensee companies, but verification through spot-check inspections in whole supply chain. b) Investigation and remediation reports. c) Standard setting for licensee agreements of US universities, d) Networking North-South and training courses for workers.

OVERVIEW OF MAIN FEATURES OF FWF, SAI, ETI, FLA, WRC

	FWF	SAI		ETI	FLA	WRC
MEMBERSHIP/ GOVERNANCE	<p>a) Members: 15 companies, 2 business associations, 2 trade unions, 3 NGOs,</p> <p>b) Executive Board: 4 business associations, 2 unions, 3 NGOs and 1 chair,</p> <p>c) Committee of Experts: 2 business associations, 2 unions, 4 NGOs,</p> <p>d) Office staff.</p>	<p>a) Board: 2 NGOs, 1 lawyer, 1 consultant, 2 businessmen, 1 president,</p> <p>b) Advisory Board: 7 NGOs, 2 unions, 1 New York City, 1 Consultant, 11 companies,</p> <p>c) Office staff.</p>		<p>a) Members: 34 companies, 16 NGOs, 4 unions,</p> <p>b) Board: 3 companies, 3 NGOs, 3 unions, 1 chair. (Government observer status),</p> <p>c) Office staff.</p>	<p>a) Members: 16 companies, 33 NGOs, 191 colleges/universities,</p> <p>b) Board: 6 companies, 6 NGOs, 3 universities, 1 chair,</p> <p>c) Office staff.</p>	<p>a) Members: 143 colleges/universities in the USA,</p> <p>b) Board: 5 universities, 5 USAS, 5 Advisory Council,</p> <p>c) Advisory Council: 24 experts,</p> <p>d) Office staff.</p>
SOCIAL STANDARDS	<p>a) Freedom of association,</p> <p>b) Collective bargaining,</p> <p>c) No forced labour,</p> <p>d) No child labour,</p> <p>e) No discrimination,</p> <p>f) Living wage,</p> <p>g) Occupational safety and health,</p> <p>h) Hours of work,</p> <p>i) Establishment of employment relationship. (Reference to ILO Conventions and to ICFTU Code of 1997).</p>	<p>a) Freedom of association,</p> <p>b) Collective bargaining,</p> <p>c) No forced labour,</p> <p>d) No child labour,</p> <p>e) No discrimination,</p> <p>f) Living wage,</p> <p>g) Occupational safety and health,</p> <p>h) Hours of work,</p> <p>i) Management systems. (Reference to ILO and to UN Human Rights / Child/Women/ Conventions).</p>		<p>a) Freedom of association,</p> <p>b) Collective bargaining,</p> <p>c) No forced labour,</p> <p>d) No child labour,</p> <p>e) No discrimination,</p> <p>f) Living wage,</p> <p>g) Occupational safety and health,</p> <p>h) Hours of work,</p> <p>i) Establishment of employment relationship,</p> <p>j) No inhuman treatment. (Reference to ILO).</p>	<p>a) Freedom of association,</p> <p>b) Collective bargaining,</p> <p>c) No forced labour,</p> <p>d) No child labour (except 14 years if legal),</p> <p>e) No discrimination,</p> <p>f) Legal minimum wage including benefits,</p> <p>g) Occupational safety and health,</p> <p>h) Hours of work (exceptions from ILO norm possible),</p> <p>i) Overtime pay at normal rate possible,</p> <p>j) No harassment or abuse. (Reference to ILO).</p>	<p>a) Freedom of association,</p> <p>b) Collective bargaining,</p> <p>c) No forced labour,</p> <p>d) No child labour,</p> <p>e) No discrimination,</p> <p>f) Living wage,</p> <p>g) Occupational safety and health,</p> <p>h) Hours of work,</p> <p>i) Establishment of employment relationship,</p> <p>j) No harassment or abuse,</p> <p>k) Women's rights. (Reference to ILO).</p>

OVERVIEW OF MAIN FEATURES OF FWF, SAI, ETI, FLA, WRC

	FWF	SAI		ETI	FLA	WRC
SCOPE OF APPLICATION	The whole supply chain of garment products including contractors, subcontractors, suppliers and licensees	Emphasis on factory/farm/facility, but also recommendations for supply chain.		The whole supply chain of garment, food and horticulture products including contractors, subcontractors, suppliers and licensees.	The whole supply chain of garment products including contractors, subcontractors, suppliers and licensees, with the exception of "minimal" facilities (short-term suppliers and small volumes).	The whole supply chain of garment products including contractors, subcontractors, suppliers and licensees. (Enforceable and enforced part of any agreement).
MONITORING/ VERIFICATION	<p>TNC/brand orientation.</p> <p>Annual monitoring, in 1st year 40%, in 2nd year 60%, in 3rd year 100% of supply base.</p> <p>Verification of 10% of each member company's supplier facilities every three years.</p> <p>Process of verifying improvements.</p> <p>FWF verification in cooperation with networks of partner organisations in producing countries.</p> <p>So far, FWF has been active in:</p> <p>Bangladesh, China, India, Indonesia, Macedonia, Poland, Rumania, Tunisia, Turkey.</p>	<p>Factory/farm/facility certification.</p> <p>10 SAI accredited audit companies (SGS, BVQI, ITS etc.) verify producers according to Guidance Document (consultation with NGOs and unions).</p> <p>NGO auditors also possible.</p> <p>SA8000 certificate is valid for 3 years. Surveillance audits every 6 months.</p> <p>As of March 2005, 655 facilities in 44 countries and from 50 industries have been certified according to the SA8000 standard.</p>		<p>TNC/brand orientation.</p> <p>Multistakeholder learning forum on monitoring and verification - experimental and research projects.</p> <p>Principle of continuous improvements.</p> <p>Experimental projects in cooperation with local stakeholders in: China, India, South Africa, Costa Rica, Zimbabwe, UK, Kenya, Sri Lanka.</p> <p>Since 1999, a total of 10 experimental projects have been carried out.</p>	<p>TNC/brand accreditation.</p> <p>Annual monitoring and verification.</p> <p>As from 2nd year onwards, internal monitoring of all facilities in supply chain.</p> <p>Independent verification in 5% of all facilities.</p> <p>Internal monitoring and verification in consultation with local labour organisations.</p> <p>12 accredited audit companies (BVQI, SGS, Verité etc.)</p> <p>According to Year Two Annual Report, the FLA verified 110 facilities in 20 countries in the year 2003.</p> <p>Accreditations: April 2004: Reebok's Footwear Compliance Programme; May 2005: Apparel Compliance Programme of six member companies.</p>	<p>TNC/brand orientation.</p> <p>WRC Agency undertakes spot-check inspections in selected licensee supplier factories.</p> <p>Investigation and remediation reports in close cooperation with local labour organisations.</p> <p>Licensee companies are required to disclose all production facilities.</p> <p>Since 2001, the WRC has conducted 13 investigations in:</p> <p>Indonesia, Mexico, Thailand USA, India, Swaziland, Honduras and El Salvador.</p>

OVERVIEW OF MAIN FEATURES OF FWF, SAI, ETI, FLA, WRC

	FWF	SAI		ETI	FLA	WRC
REPORTING/ DISCLOSURE	Member companies must publish annual reports and communicate a supplier register to the FWF. FWF publishes annual verification reports.	Audit reports go to SAI and to the companies. Other parties can get audit reports after having signed a confidentiality agreement. Auditors inform NGOs and unions about the outcome. Public list of certified facilities .		Company reports go to the ETI. ETI informs the public annually about the verification results.	Internal monitoring and independent verification reports go to the FLA staff. Annual public reports by the FLA about every participating company, university and its licensees. Public information on monitored/verified factories. Companies disclose full list of applicable facilities to FLA. Schools publicly disclose factory locations of licensed products.	WRC verification and remediation reports go to all parties involved. Disclosure of all production facilities of licensee suppliers. The WRC updates its factory list quarterly.
COMPLAINTS/ APPEALS/ CORRECTIVE ACTION	Complaints/Appeals go to the FWF which calls on companies to take corrective action. FWF oversees the implementation of remediation and informs the parties concerned.	Complaints/Appeals can go to: a) the management of the factory, b) the certifying body, c) the accreditation agency, each of them being able to initiate corrective action. Objections are being dealt with by the higher level bodies. Eight complaints between November 1999 and September 2002.		Complaints/Appeals go to ETI which then initiates corrective action in a process of continuous improvement.	Third-party complaints go to FLA which then informs those who filed the complaints/appeals about the outcome of corrective action. Also possible: complaints direct to brand companies. The FLA has received third-party complaints from countries such as El Salvador, Pakistan, Dominican Republic, Guatemala, Indonesia, Honduras and Sri Lanka during the past years.	The WRC Agency examines the complaints/appeals and initiates corrective action in cooperation with labour organisations.

OVERVIEW OF MAIN FEATURES OF FWF, SAI, ETI, FLA, WRC

	FWF	SAI	ETI	FLA	WRC	
COSTS/ FINANCING	<p>Income of the FWF by a „Social Fund Manufacturing“, by a „Social Fund Retail Trade“, by a subsidy of Novib (Oxfam Netherlands) and by membership fees.</p> <p>The FWF activities of the partner networks are paid for by the party who requests them, e.g., the FWF, a member company, or a supplier.</p> <p>FWF member companies accept responsibility for the improvement of labour conditions in the entire supply chain.</p>	<p>Annual fees for member companies vary between US \$ 3,000 - US \$ 65,000 according to revenues. Funds from government and foundations.</p> <p>Producers and suppliers pay for the SA8000 certification: per diem audit costs, may vary from a minimum of US \$ 13,500 to a maximum of US \$ 37,800 in 3 years without travel and translation costs.</p> <p>The costs for corrective action are paid by the producer.</p>		<p>ETI is funded by a grant from the government/ DFID (40%) and by membership fees (60%).</p> <p>Membership fees vary from US \$ 3,600 to US \$ 54,100.</p> <p>The costs for corrective action should be paid by the producers. However ETI refers to possible member companies' contributions through new pricing systems.</p>	<p>Administration costs are paid by annual company fees (minimal US \$ 5,000 for each participating company), and contributions by universities (1% of licensing revenues = between US \$ 100 - US \$ 50,000).</p> <p>Each participating company pays assessments into the FLA subsidiary for verification costs (LLC).</p> <p>FLA participating companies/licenses are responsible for the costs of remediation.</p>	<p>Administration costs are paid by the fees of member universities: 1% of annual licensing revenues (between US \$ 1,000 - US \$ 50,000).</p> <p>Funds from foundations and the government.</p> <p>The licensing company shall pay for the costs of the improvement of labour conditions and of the monitoring and verification.</p>
CURRENT DEVELOPMENTS	<p>The FWF is extending its membership to become a European verification initiative.</p> <p>The FWF plans to conduct training workshops in supplier factories of member companies in China.</p> <p>Member of "Joint Initiative on Corporate Accountability and Workers' Rights" (JOIN).</p>	<p>The training programme for 6000 workers in six Asian, three African and three Latin American countries will come to an end in 2005.</p> <p>Member of "Joint Initiative on Corporate Accountability and Workers' Rights" (JOIN) .</p>		<p>An „Impact Assessment“ study of ETI projects is supposed to be completed at the end of 2005.</p> <p>Member of "Joint Initiative on Corporate Accountability and Workers' Rights" (JOIN).</p>	<p>Special projects complementing the regular compliance programme, such as the „Hours of Work“ Project in China and the „Central America Project“ against blacklisting of unionists.</p> <p>Member of "Joint Initiative on Corporate Accountability and Workers' Rights" (JOIN) .</p>	<p>Continuous updates of factory database.</p> <p>Further establishment of North-South contacts, networking and trainings.</p> <p>Member of "Joint Initiative on Corporate Accountability and Workers' Rights" (JOIN).</p>

COMPARISON

Along the same lines as the earlier section on multistakeholder initiatives (MSIs), the following comparison of these five bodies concentrates on key features without going into subsidiary details.

→ INIATIVE, AIMS, METHODS, MEMBERSHIP, STRUCTURE

The strongest grass-root driven **initiatives** are the Fair Wear Foundation (FWF) and the Worker Rights Consortium (WRC). The US consumer organisation "Council on Economic Priorities" (CEP) developed the SA8000 standard with explicit reference to the International Organisation for Standardisation (ISO), the chief author of international corporate norms in the private sector. Two projects resulting from government interventions are the FLA and ETI, which were respectively fathered by the Clinton Administration and the Blair government.

All five MSIs share the **goal** of improving labour conditions in the world-wide apparel and sportshoe industry. However, the FLA, the ETI and SA8000 do not confine themselves to this industrial sector. The FLA also addresses companies in other sectors which manufacture licensed products for US colleges and universities. The ETI's field of activity also includes the food, beverage, and horticulture sectors. SAI is a cross-industry project including agriculture and the mining sector.



Whereas the SA8000 standard envisages the certification of production facilities, the goal of the FWF, ETI and the WRC is brand orientation. The FLA follows the logic of the latter, but goes a step further and accredits member brands.

The divergence between brand orientation versus factory certification reflects different responsibilities concerning compliance with code standards, which in turn implies different cost dimensions. (see below under "Costs/Finance")

Next to their key activities of verification, the five MSIs also use a variety of other **methods** to achieve better labour conditions, such as research, awareness raising and worker education. For instance, the ETI is currently conducting research on the impact of its projects on the lives of workers. Before the FWF embarks on verifying labour conditions in supplier countries of its member companies, it usually prepares background studies on the industry, social partners and the labour legislation of the country concerned. The WRC investigation and remediation reports are based on extensive research on the labour environment of specific factories and countries. In 2004, the FLA started a special project on "Hours of Work in China". All five MSIs also organise public conferences and workshops on important subjects, such as the ETI conference on the phase-out of the Agreement on Textiles and Clothing of the WTO in 2004. The SAI, the ETI and the WRC have also organised worker training courses in developing countries.

In the five MSIs, the composition of the **membership** varies with the case-to-case existence or strength of representatives of the four stakeholder categories, i.e. industry, government, unions and NGOs. The WRC is the only MSI with no industry representatives. In turn, the FLA – unlike the other four MSIs – has no union members on its Board of Directors. NGOs are represented in all five models. With the exception of one seat in the SAI Advisory Board, the **structure** of all five models exclude direct public-sector representation, although next to the SAI, government involvement in the ETI and the WRC is made obvious by public grant funding. The majority of industry in the overall membership of the ETI, the SAI, the FLA and the FWF is balanced by equal representation of all stakeholders in key structures.

→ SOCIAL STANDARDS

Unlike the FLA, the four other MSIs have very similar sets of social standards. By and large, these reflect the standards contained in the ICFTU Basic Code of

1997. The FLA code has been criticised for the following flaws: it requires no more than the legal minimum wage, allows for exceptions from the maximum 60-hour work week in peak periods and permits less than generally defined levels of overtime compensation. However, since the FLA considers itself to be a “work-in-progress”, it has already responded to this criticism by organising public debates about compensation in garment producing countries.

→ SCOPE OF APPLICATION

The scope of application varies considerably in the five MSIs.

The WRC code contains the most sweeping provisions. It covers the entire supply chain of a licensee company and requires it to present an affidavit declaring that contractors and subcontractors comply with the code of conduct.

The SA8000 standard also covers the supply chain of a member or certified company, but its goal is the certification of production facilities; retailers and brands are only called upon to encourage suppliers to abide by the SA8000 standard.

The ETI and FWF codes are applicable throughout the company and its suppliers, although not in legal terms. Moreover, ETI information material is vague in stating that “member companies are committed to the adoption of the ETI Base Code **for all or part** of their business.”

The FLA code applies to all facilities of the company itself and those of the suppliers, contractors and licensees with the exception of “minimal” facilities. This exception e.g. allows factories working under contract for up to six months in a 24-months period to escape the provisions of the FLA code – a flaw in view of the widespread use of short-term contract work in the world-wide garment industry.

→ MONITORING / VERIFICATION

All five MSIs foresee internal company monitoring as a first step towards independent third-party verification. However, the crux of the international debate

is the “independence” of the verification. The litmus test of the independent nature of the verification is the degree of involvement of the workers concerned, their unions and labour-related NGOs. This involvement boils down to their representation in the main bodies of the code institutions and their integration into the verification process, as well as, into the appeals and complaints procedure (for the latter: see below).

To varying degrees, the FWF, SAI, ETI and WRC have ensured the participation of unions and NGOs in their policy structures. The FLA's credibility suffers from the absence of unions in its leading structure. The FWF, WRC and ETI are those MSIs which carry out verification in close cooperation with partner networks in production countries.

Criticism has been voiced against the high-key use of commercial auditing companies like SGS or BVQI for the independent verification exercises of SAI. Sometimes it is principally argued that these companies cannot meet the special demands of independent auditing because they have no record of dealing with labour. It is indeed difficult to believe that workers will shed their inhibitions towards auditors who have traditionally been as closely identified with management as SGS and BVQI. However, much depends on the auditing instructions and the function of audits in the whole verification process. If, for instance, the commercial auditing is combined with NGO/union-related auditing schemes and verification like for instance in the Dutch Fair Wear Foundation, this criticism will not necessarily be valid. Both the FLA and SAI invite NGOs to undergo auditor training courses and become auditors themselves. But this too will not be helpful unless the entire verification framework seems sufficiently trustworthy to the workers and their organisations.

The independent verification system of the FLA was much improved through its reform programme of April 2002. It is now the FLA, and not the companies, which selects the facilities to be monitored, contracts with accredited auditors and vouches for the remediation process.

The ETI's verification system continues to be tested in experimental projects. The tests comprise internal company monitoring, commercial auditing, verification by academics and verification based on participation by unions and NGOs as well as mixed systems.

The WRC does not use commercial auditors for independent verification purposes. Instead, students delegations are sent to producer countries to build up contacts to workers, labour organisations and networks of independent verifiers for the envisaged WRC spot-check investigations.

Considering that the first monitoring and verification exercises, and pilots projects were started as recently as 1998, it is certainly too early to fully assess the concrete impact of all MSI projects. Nevertheless, it would be necessary to start preparations of an impact assessment soon, similar to the current one in the ETI.

→ REPORTING / DISCLOSURE

Whereas the FLA and the ETI clearly state that all reports must be forwarded both to the companies concerned and the FLA and ETI executives, which must then prepare summaries for the public, the WRC states that all reports are to be made public. The FWF requires public reports by member companies to be posted on their websites. SAI directs auditors to send reports to the company and to the SAI. Parties which have signed an agreement of confidentiality receive full reports; others receive summaries.

The disclosure of factory locations – an issue of key significance for the credibility of a code of conduct – is handled differently in the five MSIs. Disclosure and transparency make it possible to determine what percentage of a company's total number of factories has been verified. Disclosure can thus reveal whether verification of only a few supplier factories is likely to be misused to deceive the public about the company's overall performance.

The WRC demands full public disclosure of all factory locations. The FWF, FLA and ETI require a supplier register to be submitted to them by member companies. In 2002, the FLA decided to lower the percentage of independently verified facilities of companies to no more than 5% (10% in the initial membership period). But companies must provide a complete list of its applicable facilities to the FLA, and all schools in the FLA with licensing programmes have policies that require the public disclosure of factory locations where their licensed

products are made. SAI issues a public list of certified facilities and requires retailers/brands ("SA8000 Signatories") to annually disclose the number of their certified suppliers and applicants for certification as well as the approximate number of all their suppliers.

→ COMPLAINTS / APPEALS / CORRECTIVE ACTION

It is crucially important to provide for an independent body to which workers or their representatives can direct complaints and appeals. All five MSIs specify procedures allowing workers and interested parties to submit their complaints and appeals – anonymously and publicly – to the main policy-making bodies.

The WRC is a complaints-based system, therefore it has received most of the workers' complaints as compared to the other four MSIs in recent years. These complaints have triggered large-scale WRC investigations and a number of corrective actions which resulted in improvements of labour conditions in the factories concerned. In some cases, such as a complaint against union repression at the BJ&B factory in the Dominican Republic which was filed to the FLA in 2002, the FLA and the WRC worked together and finally succeeded in the majority of the retrenched workers being reinstated.

→ COSTS / FINANCING

Distinctions must be made between the normal budget costs of the five MSIs, verification/certification costs and those of remedial action. Not all of the five MSIs deal explicitly with these three aspects. These deficiencies will have to be overcome in the future.

According to SAI, factories/farms pay for their certification, although so far signatory companies have paid audit fees and technical assistance in various cases. Prompted by the logic of brand orientation, the FLA, ETI and FWF state that the affiliated companies must pay for the verification of their suppliers. The WRC pays the verification from its budget.

Concerning remedial action, the WRC states that the costs involved must be borne by the licensee company. The FWF code clearly points in the same direction by emphasising the responsibility of those at the end of the supply chain – i.e. the transnational corporations – for working conditions. The SAI vaguely calls on retailers to assist their suppliers in meeting international standards. The FLA states that the brand companies are responsible for remediation. The ETI states that the suppliers will have to bear these costs, but requires retailers to pay their suppliers adequate prices for their products, while setting favourable sourcing conditions (e.g. reliable medium-term order schemes) to allow the suppliers to implement the required social standards.

The sourcing structure of the revenues which cover the daily running costs of the five code institutions shows the following variations:

- Membership fees constitute an essential part of the budget in all five MSIs,
- The Fair Wear Foundation is the only one to be financed by parts of Collective Bargaining Agreements,
- Currently, the SAI, WRC and ETI receive government funds,
- SAI and WRC also get grants from foundations.

→ CONCLUSION

In spite of a number of similarities and steps towards a harmonisation of the five MSIs, it is also useful to sum up some of the more striking differences identified in the preceding comparison:

- The principle of brand membership in the ETI and Fair Wear Foundation stands opposed to the principle of certification in SAI and accreditation in the FLA.
- Stakeholder participation in the FLA, which lacks union partners in key structures, is less representative than in the other four code models.
- As opposed to brand orientation, the SA8000 standard shifts the brunt of

responsibility for improving working conditions from TNCs to factories in developing and transformation countries.

- The set of social standards in the FLA charter contains a number of flaws.
- Commercial auditors with little record in social auditing, occupy a key position in the SAI system.
- Independent verification of the FWF, WRC and ETI foresees close cooperation with local structures in production countries.
- The WRC and the FLA can deploy a powerful boycott weapon against companies which fail to comply with its code provisions – i.e. cancellation of the licensee agreement. The sanctions envisaged by the other MSIs consist of consumer and media pressure or withdrawal of the certificate – a less stringent economic weapon which may nevertheless prove effective if public pressure can be maintained.

During the past few years, convergence has grown in some areas of the policy and activities of the five MSIs. The future challenge will be to explore more common ground in order to strengthen the impact of these tools.

JOINT INITIATIVE ON CORPORATE ACCOUNTABILITY AND WORKERS' RIGHTS (JOIN)

A significant learning forum for the strengthening of coordination and cooperation between multistakeholder and code initiatives is the "Joint Initiative on Corporate Accountability and Workers' Rights" (JOIN) which was started in 2003. It comprises the Ethical Trading Initiative, Social Accountability International, the Fair Labor Association, the Worker Rights Consortium, the Fair Wear Foundation and the Clean Clothes Campaign. This is the first effort of its kind to bring together key organisations' different aspects of code implementation and enforcement in a collaborative programme.

The background of JOIN is that over the last ten years, codes of conduct and systems of implementation have proliferated on a global scale. Brands and retailers are faced with multiple industry standards, and suppliers are often confused

by the numbers of codes and initiatives. Local organisations in developing and transformation countries are frustrated by the many initiatives making demands on their time. Better coordination and cooperation is essential to address this confusion. It is also important to develop a shared understanding of the ways in which voluntary codes of conduct contribute to better working conditions.

The aims of JOINT are

- a) to maximise the effectiveness and impact of multistakeholder approaches to the implementation and enforcement of codes of conduct, by ensuring that resources are directed as efficiently as possible to improving the lives of workers and their families,
- b) to explore possibilities for closer cooperation between the organisations,
- c) to share learning on the manner in which voluntary codes of labour practice contribute to better workplace conditions in global supply chains.

The first testing ground for practical activities of JOIN is a common project in Turkey which started in 2004. The key questions addressed in this project will be freedom of association, wages and hours of work. The project will test a variety of approaches to code implementation in different supplier factories of participating multinational companies.

Ngadinah, worker in the Indonesian sportsshoe factory PT. Panarub, participating in the FES/SÜDWIND workshop 2002



(I. Wick)

5. Private code of conduct initiatives with emphasis on the apparel and sportsshoe industry

Next to the five code verification bodies described in chapter 4, there are also several other code of conduct initiatives which deserve to be discussed in greater detail. However, the limited scope of this brochure does not permit more than the following summary of a few examples in chapter 5 and 6.

5.1 Clean Clothes Campaign (CCC)

Founded in 1990 in the Netherlands, the CCC exists in 12 European countries today. The work of the autonomous national platforms is coordinated by an international secretariat in Amsterdam.

The CCC is a network of over 300 unions and NGOs – consumer organisations, solidarity and church groups, world shops, research institutions and women organisations which closely cooperate with partner organisations in developing and transformation countries.

The CCC aims to improve labour conditions in the worldwide garment and sportswear industry by informing consumers, influencing companies, supporting workers' organisations and campaigning on legal issues.

In cases of labour strikes, retrenchments or compensation claims of garment/sportsshoe workers, for instance, the CCC intervenes with press releases, protest letters and street actions. Currently, the **“Urgent Appeals Network”** of the CCC deals with an average of 30 cases per year in which international labour standards of the ILO and codes of conduct of global buyers have been violated.

Some CCC member organisations are involved in **worker education programmes** in developing countries and Eastern Europe. For instance, the SÜDWIND Institut für Ökonomie und Ökumene (a member of the German CCC) and the Friedrich Ebert Stiftung have been conducting trainings on codes of conduct for trade unions and NGOs in Indonesia since the year 2000.

The CCC informs and mobilises consumers by means of **public campaigns**, such as the “Play Fair at the Olympics” Campaign in 2004. This campaign drew together the CCC, Global Unions – the International Confederation of Free Trade Unions (ICFTU) and the International Textile, Garment and Leather Workers’ Federation (ITGLWF) – and Oxfam. It aimed at entrenching stronger standards for licensing and sponsoring contracts between the International Olympic Committee (IOC) and sportswear companies, as well as convincing companies to improve their global sourcing practices. In the months leading up to the Opening Ceremony of the Olympic Games in Athens in August 2004, CCC organisations and their allies organised hundreds of public events in 35 countries. More than half a million of signatures were collected in support of the campaign, and hundreds of media reports covered this campaign all over the world. Some sportswear companies were willing to move, but the IOC proved less receptive. The follow-up of this campaign is now targeting the next Olympic Games in Turin (2006) and Beijing (2008).

In recent years, the CCC has successfully mobilised municipalities and local communities in many European countries in favour of **ethical public procurement**. In France for instance, 250 communities adopted a resolution to take labour standards into account when tendering for new clothing orders. **The Clean Clothes Communities** Campaign has meanwhile spread to the Netherlands, Belgium, Spain, Germany, Sweden and the UK.

The CCC also **lobbied the European Parliament and the EU Commission** concerning initiatives on codes of conduct and corporate social responsibility. Various CCCs or CCC member organisations have also been active on the **OECD Guidelines for Multinational Enterprises** and submitted complaints to National Contact Points in OECD countries (see chapter 6.1).

In February 1998, after close consultation with worldwide partners and international union organisations, the **CCC adopted its “Code of Labour Practices for the Apparel Industry including Sportswear”**. The more than 250 sig-

natories include the ITGLWF, the European Trade Union Federation for Textile, Clothing and Leather (ETU/TCL), the Asia Monitor Resource Center (AMRC), the Transnationals Information Exchange Asia (TIE Asia) amongst others. The CCC code was shaped according to the model code of the ICFTU.

As a result of negotiations between retailers/brands and the CCC in the years 1998–2005, a number of pilot projects have been carried out in the Netherlands, France, Sweden, Switzerland, the UK and Germany. In these pilot projects, the CCC code was adopted by the parties concerned to function as an immediate or longer term reference document. Since the **CCC is not a multistakeholder initiative**, it uses pilot projects as catalysts to promote institutionalised verification systems which are a precondition to a sustained process of improvements. CCC partner organisations in garment producing countries have repeatedly warned against overestimating first improvements of labour conditions as a result of pilot projects in selected factories.

In the Netherlands and the UK, the CCCs are members of the FWF and the ETI, respectively. In 2004, after successfully concluding a pilot project with three retailers, the Swiss CCC was involved in the establishment of the verification structure ISCOM (Independent Social Compliance Monitoring). In Germany, the company Hess Natur and the CCC completed a pilot project in 2005. As a follow-up to this project, it was decided that Hess Natur became the first “Non-Dutch” member of the Fair Wear Foundation (FWF) in the Netherlands. This was seen to be an important step towards transforming the FWF into a European verification body.

5.2 Charter of the European Social Partners of the Textile and Clothing Sector

In 1997, the European Association for Textile and Clothing (EURATEX) and the European Trade Union Federation for Textile, Clothing and Leather (ETUC/TCL) signed a **“Charter of the European Social Partners of the Textile and Clothing Sector – Code of Conduct”**, in which they agreed to instruct their member

organisations to call on the companies and employees of the European textile and clothing industry to respect the five core labour conventions of the ILO. Together with the ICFTU Basic Code of Labour Practice of 1997, this code of conduct did in fact influence the forthcoming codes in this sector. In principle, however, the Charter between the employer and union federations more closely resembles a framework agreement rather than the previously described code-of-conduct initiatives.

5.3 Worldwide Responsible Apparel Production (WRAP)

In recent years, the Worldwide Responsible Apparel Production (WRAP) which was developed by the American Apparel Manufacturers Association (now American Apparel and Footwear Association) in 1998, has gained much support mainly from apparel manufacturers in southern countries. To date, 20 national manufacturing and trade associations from Central America, the Caribbean, Mexico, South Africa, Turkey and Asian countries like the Philippines and Sri Lanka are committed to the WRAP Certification Program.



WRAP pursues that factory-based certification be paid for by the factory owners. WRAP has the weakest social standards of all the code of conduct bodies established in the USA in recent years. They seldom demand more than compliance with local labour legislation and do not refer to ILO conventions. WRAP accredits both commercial and non-profit enterprises as external monitors. The members of the Board of Directors and Officers represent US apparel manufacturers such as Sara Lee, as well as academics and high-ranking former US Department of Labor officials. Due to its weak social standards and monitoring deficiencies, the WRAP programme has got little credibility among unions and NGOs.

According to WRAP statistics of January 2004, a total of 600 factories have been certified as complying with the standards of WRAP. However, a list of certified facilities has not been made available to the public.

5.4 Business Social Compliance Initiative (BSCI)

The Business Social Compliance Initiative (BSCI) was launched in November 2004 in Brussels. Under the aegis of some of Europe's largest retailers, this initiative sets out to monitor the social performance of their suppliers worldwide by utilising one common system. It is mainly intended as a sector-solution for retail in Europe, but it is also open to any non-European company or business association.



The driving force behind the BSCI is the Brussels-based Foreign Trade Association (FTA) which is the association for European commerce lobbying on foreign trade issues. For instance, the FTA has always lobbied strongly against the "protectionism" of European textile manufacturers, as well as against the creation of binding rules on Corporate Social Responsibility (CSR).

The BSCI is a European copy of the CSR sector programme of the German Retail Association for External Trade (AVE) and the German Society for Technical Cooperation (GTZ) which is supported and co-financed by the German Ministry of Economic Cooperation and Development. Between 2002 and 2005, 2000 suppliers of German retailers such as Otto, C&A and KarstadtQuelle in 12 countries have been audited in the framework of the AVE-GTZ sector programme. Although the German CCC has argued that the programme is an improvement compared to earlier insufficient or individual approaches of business companies, it has also criticized the programme because trade unions and NGOs do not have a meaningful role in the verification process.

To date, there are more than 30 member companies of the BSCI originating from seven European countries, amongst them Migros and Coop/Switzerland, Metro and Otto/Germany, C&A/Netherlands.

Similar to the AVE-GTZ sector programme, the BSCI offers no role for unions and NGOs in the leading structures. Both initiatives are monitoring bodies rather than independent verification agencies.

5.5 International Organisation for Standardisation (ISO)

Although the ISO initiative is a cross-sector initiative and not centred on the apparel and sportsshoe industry alone, it is important enough to be described here briefly.

During the past years, the International Organization for Standardisation (ISO) has initiated a process of discussing ISI Corporate Responsibility instruments taking into account the experiences from its quality management system standards (ISO 9000) and its environmental management system standards (ISO 14000).

From 7–11 March 2005, the ISO Working Group on Social Responsibility held its first meeting in Salvador, Bahia, Brazil. At this meeting it was decided to launch the development of the future ISO 26000 Standard giving social responsibility guidelines due to be published in 2008.

ISO wants to ensure that the forthcoming standard on corporate responsibility will benefit from broad input by those with a serious interest in social responsibility. ISO therefore envisages a geographically and gender-balanced representation of six designated stakeholder categories: industry, government, labour, consumers, non-governmental organisations and others.

*S.A. Chandrawathi,
president of the Free Trade
Zones & General Services
Employees Union in Sri Lanka*



(I. Wick)

6. Recent code of conduct initiatives from inter-governmental organisations and the EU

During the past few years, next to private code of conduct initiatives, a number of similar steps were also taken by inter-governmental organisations and the EU. This development has unfolded in spite of earlier international regulation of corporate behaviour, such as the "ILO Tripartite Declaration of Principles concerning Multinational Enterprises and Social Policy" of 1977. However, this declaration has largely remained ineffective in practice.

6.1 Revised OECD Guidelines for Multinational Enterprises



In June 2000, the OECD revised the Guidelines for Multinational Enterprises which it originally published in 1976. They do not legally bind companies concerned. Instead, they define the expectations of the adhering governments of both OECD member nations and non-associated countries concerning specific standards and principles. Although the new guidelines include several new topics such as sustainable development, human rights, environmental management, child and forced labour, bribery and corruption, they remain weak on a number of other issues like consumer relations, the promotion of nuclear power, genetic modification etc. However, progress was made concerning the scope of application of the revised OECD Guidelines since it was extended to include supply chains of multinational enterprises. For the first time, NGOs were given the right to submit complaints concerning the activities of companies to OECD member and adhering countries National Contact Points (NCPs).

Although the OECD Guidelines are voluntary, they bind OECD governments to follow-up complaint cases through the NCP mechanism. NCPs are government offices established to promote multinational companies' adherence to the guidelines. The structure of NCPs varies from single departments to multi-departments (tripartite, quadripartite) in different countries.

Over the past five years, 45 complaint cases have been raised by NGOs with NCPs in OECD countries, and 57 cases by trade unions.

OECD Watch, an international alliance of 47 NGOs which facilitates civil society's activities around the guidelines, made an assessment of complaint cases at the meeting of the OECD Investment Committee in Paris in September 2005. (OECD Watch 2005) According to OECD Watch, the guidelines have generally proved to be inadequate and deficient, in spite of a few cases in which specific problems were resolved and conflicts between communities and investors reduced. In view of the deficiencies, OECD Watch believes that governments must establish legally-binding, international social and environmental standards and corporate accountability frameworks.

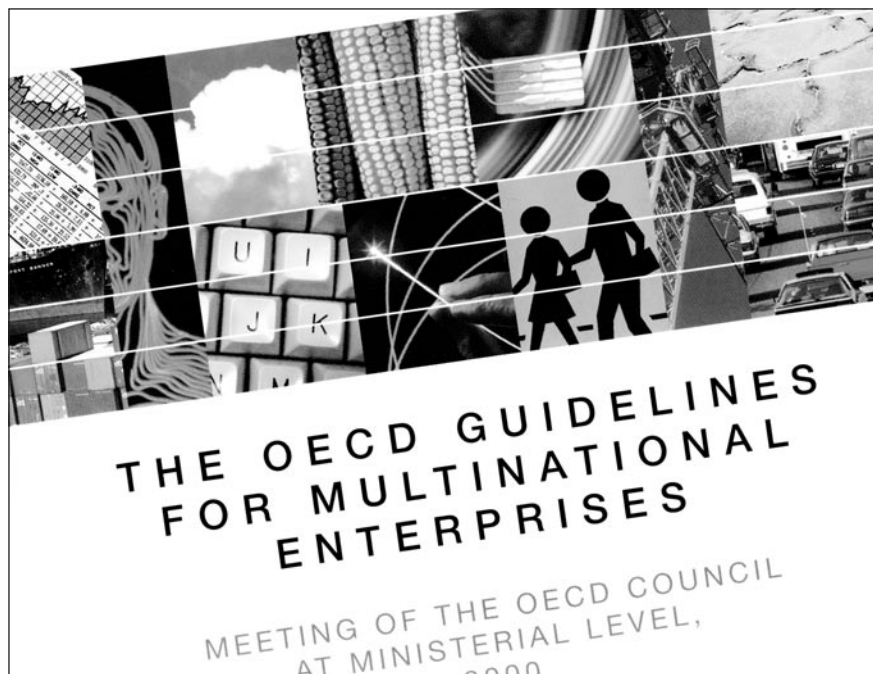

Problems highlighted in the OECD Watch review include a lack of investigative capacities of NCPs, an unwillingness to assess alleged breaches of the guidelines, attempts to exclude cases dealing with supply chain responsibility as well as delays in dealing with cases. In order for complaints to succeed in resolving problems, OECD Watch recommends, amongst others, the following:

- Accountability mechanisms such as sanctions, an enhanced peer review mechanism, and parliamentary scrutiny of NCP performance should be introduced.
- Measures should be taken to strengthen the scope of the Guidelines, particularly in relation to trade-related cases and companies' supply chain responsibilities.
- Ultimately, the examination of complaints should be in the hands of judges or ombudsmen, which are independent of governments, and with powers and resources to investigate cases, weigh evidence, reach conclusions and, where necessary, to impose sanctions. (OECD Watch 2005)

6.2 UN Global Compact



At the World Economic Forum held in Davos in January 1999, UN Secretary General Kofi Annan proposed a new initiative in support of responsible business operations and universal values under the name of the "Global Compact". It is a joint initiative of leading representatives of business, labour and civil society. Its principles refer to the Universal Declaration of Human Rights, the ILO's Fundamental Principles and Rights at Work, and the Rio Principles on Environment and Development. To date, about 2000 multinational corporations including Nike, DaimlerChrysler, Royal Dutch/Shell Group, Unilever, Rio Tinto, Deutsche Bank, Bayer and business associations such as the International Chamber of Commerce have publicly pledged to support the Global Compact. Trade union organisation such as the ICFTU and NGOs such as amnesty international are also members of the Global Compact.

The Global Compact requires companies to publish annual reports and display on their websites specific examples of progress in putting the principles of the Global Compact into practice. It also allows NGOs to publicly challenge the companies involved.

Useful as it may be as a dialogue platform, the Global Compact has already provoked sharp criticism from those who struggled for many years to promote more effective ways to improve human rights standards in the subsidiaries and supplier factories of transnational corporations. The poor human rights and labour records of some of the signatories like Nike, Shell and Bayer have been publicly exposed time and again. The Global Compact is a non-binding agreement which lacks any enforcement mechanism. It is therefore doubtful whether input from those who suffer most from human rights violations along the production chain of the companies involved will receive adequate attention.

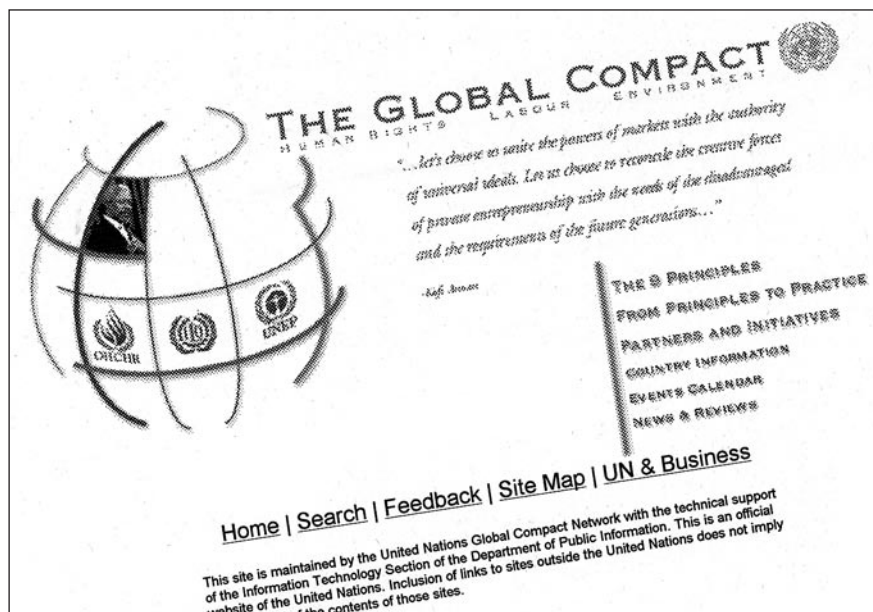

6.3 EU policy on CSR

On 13 May 2002, in a second prominent initiative on codes of conduct, the European Parliament voted for new legislation to require companies to publicly report annually on their social and environmental performance, to make board members personally responsible for these practices, and to establish legal jurisdiction against European companies' abuses in developing countries.

However, in its response to the Parliament's vote published in July 2002, the European Commission firmly rejected a regulatory approach to corporate social responsibility (CSR) emphasising the voluntary nature of CSR. The White Paper of the Commission rejects mandatory social and environmental reporting, compulsory social labelling of products and any regulation requiring pension funds in member states to disclose any socially responsible investment policies. The EU Commission emphasises its role in helping to promote CSR management skills, develop means of sharing best practice and introduce an ethical dimension to its own procurement policies. A "European Multistakeholder Forum on CSR" comprising 40 representatives from businesses, trade unions, consumer groups and NGOs under the chairmanship of the EU Commission was set up.

In June 2004, this forum published its final report including proposals for initiatives and recommendations which by and large consist of promoting voluntary CSR measures in the field of research, education, public procurement, socially-responsible investment, etc. Concerning the role of public authorities and the EU, it is proposed that they should ensure the set-up of a legal framework as well as an economic and social environment to allow companies to benefit from CSR in the market place – both in the EU and globally. No mention is made of binding companies to comply with international labour and social standards. (EU Multistakeholder Forum on CSR 2004)

6.4 UN Norms

In August 2003, the UN Sub-Commission for the Promotion and Protection of Human Rights approved the draft "Norms on Responsibilities of TNCs and Other Business Enterprises with Regard to Human Rights" (UN Norms). Although the UN Norms drew solely from existing international law including the ILO core conventions, a fierce international debate has since grown up over whether international treaties should be legally binding on businesses as opposed to governments. Not only governments such as those from the EU, but also trade unions and corporations hold the view that the primary guarantor of human rights should be states, whereas other governments, NGOs and some corporations want the norms to take on a legal, i.e. enforceable status.

The draft UN Norms were tabled to the session of the UN Human Rights Commission (UNHRC) in 2004, which mandated the Office of the High Commissioner for Human Rights to conduct a multistakeholder consultation on the "scope and legal status of existing initiatives and standards relating to the responsibility of transnational corporations and related business enterprises with regard to human rights, inter alia, the draft norms".

The report on this consultation has been discussed at the 2005 session of the UNHRC which then passed a resolution creating a special representative with a mandate, over the next two years, a) to identify and clarify standards of corporate responsibility and accountability for transnational corporations and other business enterprises with regard to human rights; and b) to elaborate on the role of states in effectively regulating and adjudicating the role of transnational corporations and other business enterprises with regard to human rights, including through international cooperation.

Whereas the ICFTU is concerned that the promotion of the UN Norms will undermine the role of the ILO, NGOs such as the International Network for Social and Cultural Rights, alongside Oxfam Community Aid Abroad, Amnesty International and others want to see the UN Norms first become the universally accepted normative framework, as a step towards a legal basis thereby hoping to better guarantee the compliance with human rights and labour standards in the world economy.

7. Perspectives

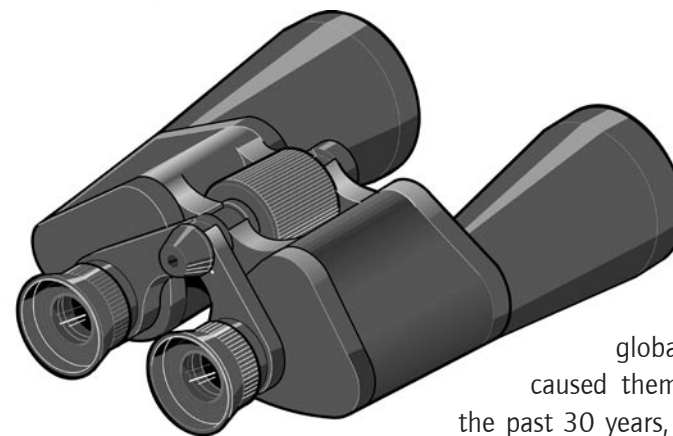

Codes of conduct enable workers to strengthen their power in factories where globalisation pressures have caused them to lose ground during the past 30 years, – but only if they know their advantages and limitations.

Codes of conduct can be useful tools to implement social standards if they fulfil certain conditions and are part and parcel of broader political activities.

To achieve their immediate aims, codes of conduct must fulfil the following criteria:

a) Substance

The social standards catalogue should not undershoot the Basic Code of Labour Practice of the ICFTU, which is more comprehensive than the core labour standards of the ILO. The key standards here are the rights to freedom of association and collective bargaining.

b) Participation

Codes of conduct can only function well if the stakeholders concerned are full partners at the relevant decision-making levels of the code verification institutions, i.e. companies, unions and labour-related NGOs.

c) Social responsibility in the production chain

Powerful actors in world trade must live up to their responsibility for labour conditions in the global production chains. They must reflect this responsibility in applying the codes of conduct. This requires transnational corporations to make decisive contributions to the improvement of labour conditions along the whole supply chain – including subcontractors and homework. Above all, corporations must change their buying practices (pricing, delivery schedules etc.) so as to enable contractors to abide by the provisions of their codes of conduct.

d) Independent verification

Corporate implementation and monitoring of codes of conduct must be verified by independent multi-stakeholder bodies.

e) Complaints and appeals

Complaints and appeals must be directed to and dealt with by an independent body. There must be confidential and effective means for workers and interested parties to register complaints.

f) Transparency

Public reporting is a crucial factor in determining the credibility of multi-stakeholder initiatives. For multi-stakeholder initiatives to become more effective and credible, it is necessary to increase cooperation with local monitoring and verification structures in developing countries and to strengthen workers' education.

During the past years, there has been a growing number of southern NGOs becoming involved in code monitoring and verification schemes like for instance GMIES in El Salvador, COVERCO in Guatemala, and EMI in Honduras. These groups have carried out independent monitoring for companies and formed regional networks.

But in order to achieve the overall aim of strengthening workers' power in the

globalised economy, it is also necessary to go beyond the limits of code-related activities.

In a wider international context codes of conduct should meet the following demands:

■ INTERNATIONAL SOLIDARITY CONTEXT

Activities related to codes of conduct should be embedded in a wider perspective of international solidarity for the sake of improving labour conditions.

Workers involved in strikes, retrenchments or military repression frequently need direct solidarity support in the form of legal and financial assistance, media coverage, worker education programmes, etc. Work relating to codes of conduct cannot be successful unless the respective priorities of workers and NGOs in southern and northern countries are taken into account.

■ NATIONAL AND INTERNATIONAL PUBLIC REGULATION

Codes of conduct are intended to complement government regulation. Close cooperation with government institutions is necessary to avoid the danger of codes of conduct being used as a substitute for publicly enforced labour laws. The enforcement capabilities of national governments and intergovernmental institutions should be strengthened. In recent months, however, tendencies towards replacing binding government regulation by voluntary codes of conduct have been strengthened. Promoters of the concept of Corporate Social Responsibility such as the EU Commission and the OECD have openly opposed stronger public regulation of business behaviour. The dangers of codes of conduct not fulfilling their task of complementing government regulation are clear: "At present, much of the social force that is promoting corporate responsibility is channelling its energies and resources towards corporate self-regulation and civil regulation. Until greater public concern and civil society activism put pressure on political parties, governments and multilateral organizations to support other regulatory approaches, it is unlikely that significant



8. The New Codes Of Conduct

SOME QUESTIONS AND ANSWERS FOR TRADE UNIONISTS (REVISED JANUARY 2003)

BY NEIL KEARNEY AND DWIGHT W. JUSTICE

NEIL KEARNEY IS GENERAL SECRETARY OF THE INTERNATIONAL FEDERATION OF TEXTILE, LEATHER AND GARMENT WORKERS' UNIONS AND DWIGHT JUSTICE IS WITH THE MULTINATIONAL COMPANIES DEPARTMENT OF THE INTERNATIONAL CONFEDERATION OF FREE TRADE UNIONS

developments in this area will be made." (Utting 2002) The United Nations Research Institute for Social Development (UNRISD) defines the role of code of conduct activities as follows: "Codes of conduct should be seen more as an area of political contestation than a solution to the problem created by economic globalisation. Strategies are required to ensure that codes of conduct are complementary to government legislation and provide a space for workers to organize. This is more likely to occur when they are a component of MSIs, rather than when they are unilaterally developed by companies or trade associations." (UNRISD 2004a)

■ LINK TO BROADER POLITICAL CAMPAIGNS

The labour practices of factories along the global production chain is by no means the only factor to be considered in implementing social standards for workers. This goal also depends on the broader political and social context, including financial market developments, gender discrimination in the labour market etc. If activities directly related to codes of conduct are not integrated into campaigns with wider political aims, the effectiveness of these tools will remain limited.

Working group session during the FES/SÜDWIND workshop on codes of conduct 2005



(I. Wick)

What are the "new" codes of conduct?

Beginning in the early 1990's, companies involved in the manufacture or marketing of brand-name goods produced internationally, often through outsourcing, began to formulate and adopt codes of conduct covering labour practices that were meant to apply to their subcontractors and suppliers. These unilaterally adopted company codes of international labour practice are the new codes of conduct.

Codes of conduct for business are not new – businesses have been using them for years to address various public concerns such as consumer rights, product safety, or environmental protection. Often businesses apply ethical behaviour codes to their employees. Codes of conduct for international business activity are not new either. In the 1970's, concern over the growing power of multinational companies led two international organisations to adopt codes for international business: the *ILO TRIPARTITE DECLARATION OF PRINCIPLES CONCERNING MULTINATIONAL ENTERPRISES AND SOCIAL POLICY* and the *OECD GUIDELINES FOR MULTINATIONAL ENTERPRISES*. These international instruments sought to protect the sovereignty of countries by defining the responsibilities, including the social responsibilities, of international business.

What is “new” about these codes?

They are new in four important ways:

- Although the ILO and OECD codes were voluntary, they are part of an international framework of principles agreed to by governments, employers and trade unions and recommended to companies. The new codes are being formulated and adopted by individual companies. Indeed, when formulating the earliest new codes, most companies ignored established standards in favour of creating their own.
- The purpose of the new codes does not include protection of the sovereignty of governments but is to address situations created by the failure of national governments and of the international community to adopt or enforce acceptable labour standards.
- Unlike most company policy with respect to labour practices, which is usually based on national law and practice, the new codes are meant to be applied internationally, regardless of where the work is being performed.
- The new codes are supposedly meant to protect workers whether or not they are employees of the company adopting the code and, in particular, they are meant to apply to the labour practices of the company's suppliers and subcontractors.

The new codes are sometimes termed private voluntary initiatives because they require a positive commitment by a company before they apply. This is in contrast to instruments such the OECD Guidelines which apply to all multinational enterprises based in OECD countries whether the enterprises has accepted them or not. The guidelines reflect the consensus of the member governments of the OECD as to what constitutes responsible behaviour of international business. The concern over the negative effects of globalisation has led to a renewed interest in the OECD Guidelines, which were revised in 2000. Among the changes has been a strengthening in the follow-up mechanism and the extension of their application to OECD-based companies operating in non-OECD countries.

Are these “new” codes just another form of public relations?

The companies adopting the new codes were responding to negative publicity generated by reports of dangerous working conditions, inhumane working hours, starvation wages, brutality and the widespread use of child labour involved in the production of clothing, footwear, toys and other labour-intensive manufacturing, as well as in the production of many agricultural products. Companies operating in other sectors are now adopting similar codes.

The early new codes rarely went beyond pledging not to use child labour and to respect national law and the companies adopting them appeared to have had little intention of doing anything to make good on what essentially were promises to the public. In some cases, the companies established a “complaints procedure” and invited NGOs and trade unions to take evidence of exploitation and abuse to the company before “going public”. Many of the later codes reflect the demand that international standards be used, and increasingly, com-

COMPETITIVE ADVANTAGES MENTIONED BY CODES

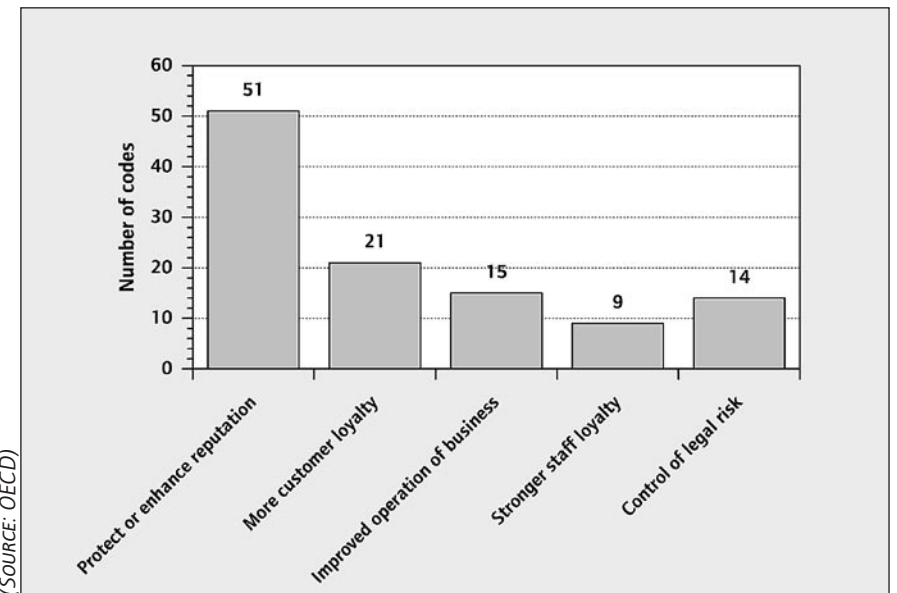

panies are being forced to consider systems of giving effect to their codes and of assuring the public that their codes are being respected. However, many of the new codes are still public relations exercises and the vast majority of these kinds of codes are not built around fundamental international labour standards. The limited research conducted to date suggests that codes have not produced major changes in labour practices.

Why should trade unions be concerned with these codes?

Whether they are policies or promises, the new codes are about labour practices and therefore cannot be ignored by trade unions. Most companies adopt codes without involving trade unions in any way and will continue to adopt codes even if trade unions dismiss or ignore codes. Indeed, the new codes have become an important part of larger debates on corporate responsibility and globalisation. The new codes are sought after by many NGOs and are attracting the interest of business and industry groups, governments, international organisations and academics. They have spawned an entire new industry of consultants and enterprises offering "social auditing" services to companies.

Because trade unions have long demanded that multinational companies assume responsibility for their international activities, it is difficult to see how they can object in principle to what is an acknowledgement of social responsibility by business. One objection to the new codes is that they can be consistent with a philosophy that seeks to privatise what ought to be the legitimate functions of government. They can be used by companies to avoid dealing with trade unions. On the other hand, the new codes can be equally consistent with the promotion of international labour standards and of a binding international framework for responsible corporate behaviour. The new codes can also be used to promote collective bargaining and to help workers form trade unions. Codes can be a means to support organising activities and to commit companies publicly to respect the right to organise and collective bargaining.



(H. KLÖPPER)

Body check after work at garment factory near Jakarta/Indonesia

Where they are truly applied, codes may end some of the worst forms of exploitation and abuse. They also may provide opportunities for international trade union organisations to engage multinational companies. Trade union involvement with the new codes, and especially international trade union co-operation, may determine whether the new codes are used as a means to privatise the proper functions of governments and absolve governments and intergovernmental organisations of their responsibilities or whether they contribute to building a system of international social justice and industrial relations.

Should national trade union organisations negotiate codes?

The low level of trade union organisation in many of the industries and countries most concerned suggest that insisting that codes must always be negotiated with trade unions is not realistic. The international scope of the new codes makes it questionable whether it is either practicable or appropriate for national trade unions to seek to negotiate these new codes.

Because the new codes are international in scope and almost all collective bargaining takes place within national legal frameworks, the national trade union negotiating a code may be accepting responsibilities that it cannot discharge. Under these circumstances, the negotiated code may have no greater effect than a unilaterally adopted code – the only difference may be to involve national trade unions in a “complaints procedure” which only protects the company. Instead of becoming a party to a signed agreement, national trade unions can avoid complications by seeking to advise companies on appropriate code content and implementation.

Serious complications can arise when a trade union in one country seeks to negotiate working conditions for workers in another country. Where the trade union negotiating a code is from the home country of a multinational company, it may be open to charges of protecting purely national interests or protecting long-standing relationships with prominent national companies. It is unacceptable for trade unions to negotiate agreements covering workers in another country where the workers concerned are represented by their own trade union unless, of course, the foreign trade union has requested assistance and is consulted at every step. Even in this situation, it would be better to involve the appropriate Global Union Federation.

Almost all of the companies adopting the new codes are operating in sectors where most workers do not belong to trade unions and in countries where trade union rights are not respected. The exploitation and abuse of workers, which led to the need for a code in the first place, occurs because the rights of workers to join or form independent trade unions and to bargain collectively are not respected. Where workers can form independent trade unions and bargain, there may be little need for a code of conduct.

There is a big difference between speaking out on behalf of workers who are not represented and seeking to negotiate on their behalf. To say that it is possible to negotiate for unorganised workers is to say that workers can be represented without their own trade unions. The moral obligation of all trade unions toward unorganised workers is to assist them in joining or forming their own trade unions and to prevent or discourage others – whether they are governments, political parties, employers or NGOs – from claiming to speak for them.



(CIR)

Maquila worker in the Export-Processing Zone “Las Mercedes” in Managua/Nicaragua

Whether a trade union should negotiate an international code boils down to this: is it possible for the trade union to consult the authentic representatives of the workers who would be affected by a code? The best example of a positive answer to this question occurred during the 1980’s, where trade unions in the home countries of multinational companies operating in South Africa during apartheid were able to negotiate codes on behalf of black workers in South Africa. This was possible only because the workers concerned had already established genuine, albeit illegal, trade unions and the trade unions negotiating the codes closely co-operated with these trade unions. These circumstances were exceptional.

What is the difference between a code of conduct and a framework agreement?

Some of the obstacles to negotiated codes can be overcome and some advantages gained by distinguishing between framework agreements and unilaterally-adopted company codes of labour practice. A framework agreement is an agreement negotiated between a multinational company and a Global Un-

ion Federation (GUF) concerning the international activities of that company. Global Union Federations are the international associations of trade unions grouped by industry, economic sector or profession. A number of framework agreements have been negotiated, with varying subject matters and details. Although an international code of conduct can be part of a framework agreement, and sometimes is, the main purpose of a framework agreement is to establish an ongoing relationship between the multinational company and the international trade union organisation.

Trade unions that want to engage multinational companies over their labour practices in other countries should do so in close co-operation with the appropriate GUF. Because the GUFs have affiliates throughout all regions of the world and often in both home and host countries, they are the legitimate international voice of workers in their respective industries or economic sectors. An additional advantage of working through GUFs is that trade unions will be addressing specific situations while, at the same time, strengthening the international trade union movement.

There are additional reasons to distinguish between unilaterally adopted company codes and framework agreements. One is that trade unions should not automatically dismiss codes because they are not negotiated. Trade unions can engage multinational companies over their codes without becoming party to them. Another difference is content. A framework agreement can cover a variety of subjects. For reasons explained below, a unilaterally adopted company code of labour practice should be limited to setting forth minimum standards.

What should trade unions want codes of conduct to do?

The challenge for trade unions is to make sure that the real effect of the new codes is to promote freedom of association and the right to collective bargaining and that they are not used to substitute for these two basic workers' rights. The role of trade unions is to insure that the link between exploitation and abuse of workers on the one hand, and the oppression of workers on the other,

THE LABOUR CONTENT OF THE CODES

	PERCENTAGE OF CODES MENTIONING ATTRIBUTE*
Reasonable working environment	75,7
Compliance with laws	65,5
No discrimination or harassment	60,8
Compensation	45,3
No child labor	43,2
Obligations on contractors/suppliers	41,2
No forced labour	38,5
Provision of training	32,4
Working hours	31,8
Freedom of association	29,7
Specific mention of "human rights"	25,0
Monitoring	24,3
Right to information	13,5
ILO codes mentioned	10,1
Promotion	8,8
Reasonable advance notice	3,4
No excessive casual labour	3,4
Flexible workplace relations	0,7

(SOURCE: OECD)

is understood and reflected in codes of labour practice. Companies should not use codes as a means of avoiding trade unions. Similarly, national or local trade unions should not accept codes where they could otherwise negotiate collective agreements for the workers they represent. Codes of conduct promote good industrial relations.

How can codes promote collective bargaining?

The content of the code is crucial in two ways. First, a code of labour practice should always contain explicit provisions respecting the right of workers to either form or join trade unions and to bargain collectively. Some suppliers have used their obligation to abide by a company code as a reason not to continue a collective agreement negotiated with a local trade union and others have used codes as reasons not to recognise trade unions. Trade unions

should regard explicit recognition of freedom of association and the right to collective bargaining as central provisions of any code of labour practice and, where these provisions are missing, demand that they be included. These rights enable workers to protect other rights, as well as their interests on a wide range of issues. The adoption in June 1998 by the ILO Conference of the ILO Declaration on Fundamental Principles and Rights at Work demonstrates the world consensus with respect to freedom of association and the right to collective bargaining, as well as all of the core ILO labour standards.

Second, codes should not contain provisions that are more appropriate for collective bargaining agreements. Unilaterally adopted company codes should only contain minimum standards that are explicitly recognised as such. The ICFTU strongly recommends that codes of labour practice be based on internationally recognised labour standards and include explicit reference to all of the fundamental labour standards of the ILO. Trade unions are invited to use the ICFTU/ITS Basic Code of Labour Practice as a benchmark in evaluating voluntary company codes of conduct.

Can international labour standards apply to companies as well as to governments?

Codes of conduct are no substitute for legislation and its effective implementation. However, company codes of conduct that promote knowledge and understanding of international labour standards indirectly promote government responsibility and may even be used to promote an international framework for business, which includes respect for workers' rights. These beneficial effects will only be possible from codes of conduct that are based on already established international standards, including ILO standards. It is not difficult to transpose the fundamental ILO conventions into obligations for international business.

Businesses seeking to define their social responsibilities almost always stress respecting the values of the community. For international business, this should mean respecting the standards of the international community. The ILO is the organisation established by the international community for the purpose of setting international labour standards.

ISSUES ADDRESSED IN APPAREL COMPANIES' CODES OF CONDUCT

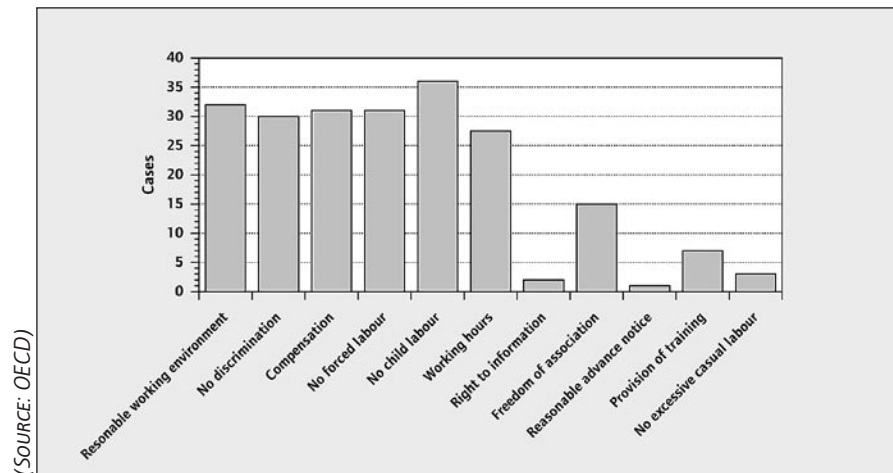

How can codes of conduct promote collective bargaining in countries where independent trade unions are banned?

The rights of workers to join or form trade unions and to bargain collectively are human rights that are only fully respected in democracies. Nevertheless, trade union experience is that, even under dictatorships, workers have been able to create or enlarge space for trade union organising and collective bargaining with some employers. This was the experience in Chile, Korea, Poland, South Africa and Turkey when these countries were dictatorships. Companies respecting human rights should therefore be alert to the possibilities of creating and enlarging the space for workers' self-organisation. In any event, companies should always avoid being party to state repression.

Some advocates of the codes of conduct that include freedom of association and the right to collective bargaining do not support boycotting countries that deny these rights. Instead, they want companies doing business in these countries to help create an environment where these rights are respected. One idea is for companies to require their suppliers to facilitate alternative or "parallel" means of workers' organisation. The supplier would not be required to estab-

lish any organisation, but would be expected to provide the workforce with the opportunity to do so in the form of elected consultative committees on health and safety, productivity and many other relevant issues.

Great care must be taken in implementing any provision to provide “parallel means” because the intervention of an employer in workers’ organisations can, in itself, constitute a violation of freedom of association. Some employers would use any provision to set up organisations that they control as a means of avoiding trade unions or of using such a provision as evidence that workers do not need trade unions. For this reason, a provision concerning alternative means should only apply in a very limited set of countries. These would include those few countries such as Saudi Arabia where all trade unions are explicitly banned and those countries such as China where the state has created and controls a labour organisation monopoly. The term “parallel means” is meant to suggest that the arrangements would have a separate existence from any official government controlled system of labour organisation.

Companies doing business in countries with repressive regimes have a greater obligation to be transparent in their operations and should work with international trade union organisations so as to increase the positive and decrease the negative effects of their involvement in these countries. The purpose of encouraging alternative or parallel means is not to create substitutes for genuine trade unions or to otherwise obtain the beneficial effects of true industrial relations, but to avoid complicity in repression and to contribute toward the eventual end of repression.

Should codes reflect the special conditions in certain countries?

Some trade unions and NGOs talk about negotiating codes of labour practice reflecting the “special situation” or “unique circumstances” in their respective country or region. Settling for less than minimum international standards would defeat the whole purpose of an international code. Governments justify the repression of workers’ rights and trade unions by claiming “special situa-

tions” and “unique circumstances” and many companies have found it convenient (and profitable) to accept this argument and not interfere by “imposing” their own “cultural values”. One clear example of an unacceptable “cultural” exception to international standards is discrimination against women.

Although it is reasonable to expect that the content of codes will vary from company to company and between industries, the basis for these differences should centre on the relevancy of the various international standards and established best practice. For instance, in some codes it may be especially appropriate to reflect certain health and safety standards.

Should trade unions be responsible for implementing codes of conduct?

No. Companies should be responsible for implementing their own codes of conduct. Codes should be viewed as company policy and as a management tool to solve problems. Where a company has promulgated a code of conduct, it is morally bound to give it effect. Implementation is anything done to give a code effect.

Factory in Export-Processing Zone San Bartolo in El Salvador



(H. HENSCHEN/CIR)

A company that takes its code of conduct seriously will not leave it to its public relations department or agency, but will place the overall responsibility for the implementation of the code at the highest levels and incorporate code compliance into all relevant management systems. This means assigning responsibilities throughout the company. One responsibility should be assigned to the legal department – observance of the company code should be made an enforceable, and an enforced, part of the agreements the company enters into when outsourcing. Other responsibilities belong with the personnel department – company personnel should receive training in implementing the code. Buyers must be permitted to take the cost of code compliance into account when negotiating contracts with suppliers. The labour practices of suppliers must receive the same attention as the quality of their output.

The workers covered by a code should be provided in every case with a full and understandable explanation of the code, both verbally and in written form. Workers covered by a code should also be provided a confidential and accessible means to report code violations.

In the end, the real test of implementation is whether a company does anything to correct unacceptable labour practices where they are discovered.

What does “monitoring” mean?

Where a company has adopted a code of conduct covering the labour practices of its suppliers and sub-contractors, it has acknowledged some measure of responsibility for their labour practices. The most basic obligation that follows from this responsibility is to know the actual situation in which work covered by the code is performed. This led to demands that it was not enough for companies to adopt codes but that they should also “monitor” compliance with their code. “Monitoring” came to be considered a basic part of implementing of a code.

The term “monitoring” has come into widespread use with respect to the new codes. However, the term, as it is used in connection with supplier codes, is misleading and other terms are more accurate. As it is commonly understood, the term “monitoring” implies a constant, continuous or, at least, a frequently repeated process. In most cases, this would not be possible for many compa-

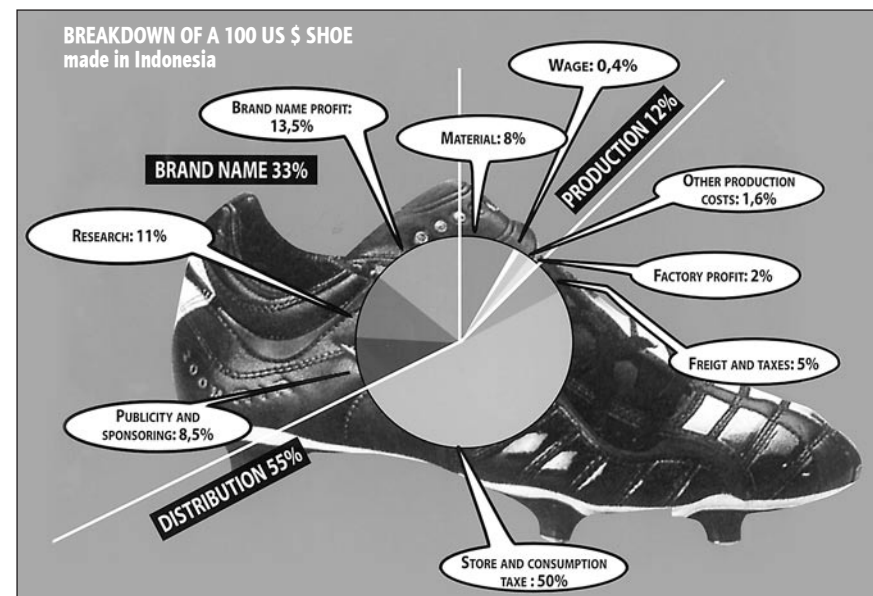

(SOURCE: MDM/OXFAM BELGIUM)

nies that adopt codes to do. The companies that adopt the new codes are likely to have many suppliers, which may use many workplaces. Often these suppliers will have subcontractors. What companies who claim to “monitor” their codes actually do is to visit the workplaces of their suppliers or to engage others to make a visit. This occurs infrequently or only once. Given the many thousands of workplaces that a sourcing company may have acknowledged responsibility for, this is not surprising.

These visits can be described as “inspections” and they can be an important part of code implementation and a sign of commitment. However, these workplace visits should not be described as “monitoring”. Sometimes inspections are part of a process that involves cross checking claims made by a supplier. Where the inspection seeks to compare different kinds of evidence with respect to code compliance, the term “auditing” could be used. An example of the auditing approach would be to compare company records concerning wages or hours with pay slips and worker interviews. Sometimes, companies who accept responsibility for the labour practices of their suppliers will chose their suppliers only after making an “assessment” of the likelihood that their labour

practices will conform to their code. Thus, the terms “assessments”, “audits” and “inspections” may be more accurate ways to describe what companies do to fulfil this basic obligation of being aware of the labour practices of their suppliers.

Trade unionists should be especially interested in reserving the use of the term “monitoring” for constant or continuous activities. Where workers are organised in a trade union at their workplace, their trade union can serve as a true “monitor” of labour practices. Indeed, the constant presence of the trade union and the protection that it affords its members, make trade unions the best and most efficient means of “monitoring”. Of course, this only applies to workplaces where the workers belong to trade unions and where the trade union is recognised and permitted to function properly.

Should trade unions be responsible for monitoring codes?

No. Companies should be responsible for monitoring or determining compliance with their own codes of conduct. Trade unions monitor workplaces where they have members in the interest of their members. Trade unions are often the organisations most aware of labour practices in their respective industries and countries. Their familiarity with unorganised workplaces arises from their role in bringing the benefits of trade unionism to unorganised workers. It is not, however, the role of trade unions to monitor or check on workplaces in the interest of ensuring that a company complies with its own policy.

Trade unions should be regularly consulted as part of the code implementation process and, of course, as part of the industrial relations process. There may be cases where trade unions enter into agreements with a company to assist this process – for example by providing interpreters or interviewers. Indeed, this may provide the trade union with access to unorganised workers. But trade unions should not enter into agreements with companies whereby they assume the responsibility for “monitoring” workplaces if they are not also legally recognised as the representatives of the workers concerned.

What about “independent monitoring”?

At present, there are no good examples of “independent monitoring” and the subject is surrounded by controversy. Indeed there is considerable confusion surrounding the term “independent monitoring” and the term “verification” is preferred by a growing number of persons most familiar with the problems involved.

The idea behind “independent monitoring” was that a code will be more credible if compliance were “monitored” by persons or organisations independent of the company that has adopted the code. Some companies have engaged commercial enterprises such as accounting firms and management consultancies to perform their “independent monitoring” or “third party verification”. Other companies have, in arrangements with their suppliers and subcontractors, designated local NGOs to be their “independent monitors”. In all of these cases, the companies, through their agreements with enterprises or NGOs, control the process.

The emerging consensus is that the term “independent monitoring” (and similar terms such as “third-party monitoring”) is more confusing than appropriate. These terms obscure the obligation of any company adopting a code of labour practice to determine whether its code is respected. Moreover, the object of “independent monitoring,” which is to provide credibility, is also obscured.

In order for so-called “independent monitoring” to be credible, it would have to be performed by qualified persons working to agreed processes. Both the qualifications of the persons and processes involved would have to be established independent of the company whose code was being monitored. In the absence of professional standards, there is no reason to accept the independence of any enterprises or NGOs engaged by a company to perform this work. Engaging a commercial enterprise or designating an NGO to “monitor” code compliance is little different from having the work done by company personnel.

Trade unionists should also be concerned where “independent monitoring” programmes are used to introduce outside organisations into the workplace on a permanent basis with the effect of discouraging or preventing workers from joining or forming their own organisations. This is especially serious where the

'independent monitor' is an NGO presenting itself as an alternative to trade unions.

"Verification", in contrast to "independent monitoring", is a better term. It is recognised by many involved with supplier codes as a comprehensive process, involving checking on both code compliance of the supplier and the implementation systems of the company that has adopted the code. The thinking on verification is developing constantly. Many have concluded that verification should be carried out by professionals working to defined standards and trained in skills including factory inspection, accountability, health and safety and detection techniques. Whether verification is performed by commercial enterprises or non-profit agencies, the work would have to be performed following carefully defined standards and rules. It is important to be able to distinguish between the responsibility of a company to be aware of the labour practices of its suppliers and the credibility of any claims that the company may be making publicly about its code or these practices.

Who will decide whether systems of verification are credible?

Trade unions must have a role in establishing and accrediting systems of independent verification. This does not mean that only trade unions could or should verify compliance with codes. It does mean that trade unions must have a role in determining the rules or procedures, training and qualifications as well as other standards for verification and for those who would perform verification. Systems of verification must also insure that trade unions are consulted during the verification process.

Two of the most promising instances where trade unions are working with companies and NGOs to explore or establish verification systems are the Social Accountability International or SAI (formerly CEP AA) and the Ethical Trading Initiative (ETI).



Informal sector workers in Harare/Zimbabwe

SAI was established by The Council on Economic Priorities (CEP), a US-based NGO and, following a similar process as that used in ISO standard setting, it has developed an international standard for labour and human rights, known as SA 8000. The Advisory Board consists mostly of representatives from corporations and NGOs, but also includes trade union representatives.

A more experimental approach has been taken by the Ethical Trading Initiative, a partnership of NGOs, companies and trade unions, which is supported, in part, by the British government. ETI is meant to serve as a forum whereby information relating to code implementation and verification is exchanged and a means of conducting pilot studies to test various ways of monitoring and verifying codes. Several other initiatives involving companies, trade unions and NGOs have been formed in other countries. Of particular note is the Netherlands-based Fair Wear Foundation. This is also a "multi-stakeholder" initiative involving sourcing companies, trade unions, and NGOs established to implement an agreed code.

The ILO, because of its tripartite structure and the fact that it is a repository of expertise in all matters of labour practices, including labour inspection, may be the most appropriate organisation to establish benchmarks for the training of persons performing labour inspections and “social audits”, for standards of verification and for the credible development of any profession of “social auditing”. For this reason, and because the ILO can provide technical assistance to both social partners, the ICFTU is seeking greater involvement by the ILO with the new codes. Any involvement of the ILO in this area, however, should be firmly rooted in its commitment to labour standards, social dialogue and tripartism.

What about “social labelling”?

Trade unions should not support the certification of labour practices through the use of “social labelling” on products, at least not before accredited systems of independent verification are established and proven effective and reliable. Such product labels imply a guarantee that the item was produced free of exploitation and abuse. But, unlike product content or safety labels, the claim cannot be verified by testing the product itself. A label covering labour practices could only be credible if there was constant policing of the workplace – a condition that exists only where secure and independent trade unions are permitted to perform their proper functions and even then, only where they are supported by enforceable and enforced labour regulation in an open and democratic society.

This caution need not apply to labels developed to address some specific abuses such as child labour. In particular where producers are participating in an internationally recognised programme to eliminate child labour, then a label that indicates that the company concerned is participating in a specific programme is acceptable. Even here, care must be taken that only the participation in the programme is being certified and not the labour practices used in the product bearing the social label. This caution also does not apply to “fair-trade” labels involving trading relationships between small producers of mainly commodity products in developing countries and consumers in developed countries where

these labels do not seek to “certify” labour practices. Nor does it apply to environmental labels (“eco-labelling”). In recent years some environmental and fair trade labelling schemes have begun to make claims about labour practices. These developments are cause for concern.

What is the role for NGOs in codes of conduct?

NGOs have often been the leading organisations in campaigns for codes and they have brought the issues of exploitative and abusive labour practices to the attention of the public in many countries. Trade unions should welcome these efforts and work with NGOs in this area. NGOs should work with the appropriate trade union organisations when campaigning over labour practices. NGOs have a vital role in exposing the abuse of workers throughout the world. It is important that they continue to put pressure on both governments and business to behave responsibly.

NGOs should be encouraged to base campaigns for codes of labour practice on minimum international labour standards and always to include the right of workers to organise and to bargain collectively. Demands that are more appropriate to collective bargaining should be avoided and NGOs should not participate in arrangements with companies that have the effect of substituting for independent trade unions. In any event, NGOs should not attempt to negotiate labour practices with companies or to establish regular consultative relationships with companies concerning their labour practices.

How are the new codes related to “corporate social responsibility”?

The new codes of conduct have become part of a broader debate over the social responsibilities of business. One idea of “Corporate Social Responsibility” (CSR) is being promoted as the voluntary responses by business to social

and environmental concerns. Because the new codes of conduct are voluntary initiatives, they are often linked with this notion of CSR.

There are some trade union concerns with CSR that are the same concerns that trade unionists should have with the new codes. Sometimes, businesses appear to be using CSR as a way of avoiding regulation. The important role of government is unrealistically diminished and the ability of business to resolve social and environmental problems is unrealistically exaggerated. Many embracing CSR focus entirely on management and treat the employees of an enterprise as just one group among many other “stakeholder” groups. Indeed, the responsibility of businesses to have good industrial relations and to participate in social dialogue as a social partner with workers rarely figures into the new CSR idea. In this sense, the new CSR idea can, at times, resemble the older and discredited idea of paternalism. Business should not use the interest in CSR in a way so as to avoid responsibilities by promoting the idea that enlightened management can substitute for the role of governments and trade unions in society.

Similarly, the new codes of conduct must not be allowed to be treated as an acceptable substitute for either governments or for trade unions. The demand for supplier codes came about as a result of situation caused by the failure of governments to fulfil their responsibilities and by the repression of trade unions. For the new codes to have a positive and sustainable impact, they should contribute to a culture of compliance with law and standards that strengthens the ability of governments to protect workers from abuse and exploitation. Whether the new codes have a positive and sustainable impact will also depend on whether they can create space for the workers concerned to organise trade unions to protect their own interests.

Another area where trade union concerns over CSR are the same as those that trade unionists should have with respect to the new codes concerns the role of standards. Simply put, business must not be allowed to define its own responsibilities, but should use existing, recognised and legitimate standards. With respect to the broad social responsibilities of business, two of the most important of these standards are the ILO Tripartite Declaration of Principles concerning Multinational Enterprises and Social Policy and the OECD Guidelines for Multinational Enterprises. As noted earlier, we believe that it is important for

supplier codes to reflect the principles underlying ILO standards, especially all of those standards that have been identified as fundamental rights at work. It must be stressed, however, that, while it is very appropriate for companies sourcing internationally to require their suppliers to respect these minimum human rights standards, the social responsibilities of business go well beyond respecting human rights and minimum conditions. Codes of labour practice based on minimum internationally recognised standards and meant for suppliers are an insufficient basis for companies to define their own social responsibilities with respect to work and workers.

Where do the new codes fit into the trade union strategy for globalisation?

The new codes are a phenomenon that emerged in 1990's and presents both challenges and opportunities for trade unions. As already noted, the new codes must not be allowed to become an alternative to national law or industrial relations or to absolve governments from their responsibilities. Nor should the new codes become an impediment to establishing enforceable international rules for multinational companies. More immediately, the new codes must not be used by companies to avoid trade unions and collective bargaining.

Trade unions should respond to the new codes of conduct in ways that makes them complementary to the overall objectives of the trade union movement, including the campaign for a workers' rights clause in international trade and investment agreements. The new codes should be used to promote acceptance of international labour standards and an understanding that exploitation and abuse occur because trade union rights are not respected.

The international nature of the new codes requires international trade union co-operation. The new codes may provide an opportunity to strengthen the international trade union movement by engaging multinational companies on the international level and may even lead to international social partnerships. Efforts must be made to strengthen the capacity of trade unions, particularly in developing countries, to take full advantage of the new codes.

9. Appendix

List of Selected ILO Conventions

- a) **Freedom of association and protection of the right to organise**
(No. 87, 1948)
- b) **Right to organise and collective bargaining**
(No. 98, 1949)
- c) **Forced labour**
(No. 29, 1930)
- d) **Minimum age**
(No. 138, 1973)
- e) **Discrimination in employment**
(No. 100, 1951 and No. 111, 1958)
- f) **Living wage**
(No. 26, 1928 and No. 131, 1970)
- g) **Occupational safety and health**
(No. 155, 1981)
- h) **Hours of work**
(No. 1, 1919)
- i) **Establishment of employment relationship**
(not yet ILO Convention)

The ILO Conventions under a), b), c), d) and e) belong to the „core labour standards“ which are the basis of the “ILO Declaration on Fundamental Principles and Rights at Work“ adopted by the 86th International Labour Conference on 18 June 1998 in Geneva. This Declaration is binding for all ILO member countries.

Abbreviations

ATTAC	International Movement for the Democratic Control of Financial Markets and their Institutions
AVE	Außenhandelsvereinigung des Deutschen Einzelhandels = German Retail Association for External Trade
BSCI	Business Social Compliance Initiative
BVQI	Bureau Veritas Quality International
CCC	Clean Clothes Campaign
CEP	Council on Economic Priorities
CEPAA	Council on Economic Priorities Accreditation Agency
EFTA	European Fair Trade Association
EPZ	Export-Processing Zone
ETI	Ethical Trading Initiative
EWC	European Works Council
FLA	Fair Labor Association
FLO	Fair Trade Labelling Organisation
FTA	Foreign Trade Association
GATT	General Agreement on Tariffs and Trade
GUF	Global Union Federation
GUN	Global Union Network
GTZ	Gesellschaft für Technische Zusammenarbeit = German Society for Technical Cooperation
ICEM	International Federation of Chemical, Energy, Mine and General Workers' Union
ICFTU	International Confederation of Free Trade Unions
IFAT	International Federation for Alternative Trade
IFBWW	International Federation of Building and Wood Workers
ILO	International Labour Organisation

IMF	International Monetary Fund
IMF	International Metal Workers' Federation
ISO	International Organisation for Standardisation
ITGLWF	International Textile, Garment & Leather Workers' Federation
IUF	International Union of Food, Agricultural, Hotel, Restaurant, Catering, Tobacco and Allied Workers' Association
JOIN	Joint Initiative on Corporate Accountability and Workers' Rights (Ethical Trading Initiative, Social Accountability International, Fair Labor Association, Fair Wear Foundation, Worker Rights Consortium, Clean Clothes Campaign)
MSI	Multistakeholder Initiative
NCP	National Contact Point (see OECD Guidelines for Multinational Enterprises)
NEWS	Network of European World Shops
NGO	Non-governmental organisation
OECD	Organisation for Economic Co-Operation and Development
SA8000	Social Accountability 8000
SAI	Social Accountability International
SAP	Structural Adjustment Programme
SGS-ICS	International Certification Services
TNC	Transnational Corporation
UNDP	United Nations Development Programme
UNI	Union Network International
WRAP	Worldwide Responsible Apparel Production
WRC	Worker Rights Consortium
WTO	World Trade Organisation
WWC	World Works Council

Glossary

In recent years, the following terminology and definitions have been developed in the international debate on codes of conduct:

■ Implementation

→ This means anything done by a company to give effect to a code.

■ Monitoring

→ This means anything done by a company to check if the provisions of a code are being observed. Monitoring as an ongoing process is basic to implementing. Often this is also called "internal monitoring".

■ Verification

→ Also called "independent verification". This means institutionalised checking on implementation and monitoring systems of a company by an independent body.

At the beginning of the international code of conduct debate, "independent verification" was often also called "independent monitoring". The independent verification institution can appoint commercial audit companies and/or non-profit agencies to perform audits following carefully defined standards and rules (also called 'social auditing').

■ External Monitoring

→ This means monitoring by third parties on a spot-check basis, and not on a regular institutionalised basis.

■ Social auditing

→ See under "Verification".

(See also "Bibliography": the "Monitoring and Verification Terminology Guide" of the Clean Clothes Campaign).

Bibliography

- Abrahams, Désirée (2004).** "Regulating Corporations: A Resource Guide". UNRISD, Geneva.
- Ascoly, Nina and Ineke Zeldenrust (2001).** "Discussing Key Elements Of Monitoring And Verification". SOMO, Amsterdam.
- Ascoly, Nina, Joris Odenziel and Ineke Zeldenrust (2001).** "Overview Of Recent Developments On Monitoring And Verification In The Garment And Sportswear Industry In Europe". SOMO, Amsterdam.
- Asia Monitor Resource Centre (2003).** "Asian Transnational Corporations Monitoring". Workshop Report 2002, Hong Kong.
- Asia Monitor Resource Centre (2004).** "A Critical Guide To Corporate Codes Of Conduct – Voices From The South". Hong Kong.
- Bendell, Jem (2004).** Barricades And Boardrooms: A Contemporary History Of The Corporate Accountability Movement". Programme on Technology, Business and Society, Paper No. 13, UNRISD, Geneva.
- Chen, Martha et al. (2005)** "Progress Of The World's Women: Women, Work & Poverty". UNIFEM, New York.
- Clean Clothes Campaign (2003).** "Monitoring And Verification Terminology Guide For The Garment And Sportswear Industry". Available online at www.cleanclothes.org/codes/03-08-26.htm.
- EU Multistakeholder Forum on CSR (2004).** Final Report. Available online at http://forum.europa.eu.int/irc/Empl/csr_eu_multi_stakeholder_forum/info/data/en/CSR%20Fom%20roundtables%20reports.htm
- Ferenschild, Sabine and Ingeborg Wick (2004).** "Global Game For Cuffs And Collars – The Phase-Out Of The WTO Agreement On Textiles And Clothing Aggravates Social Divisions". SÜDWIND-texte 14, Siegburg.
- Fichter, Michael and Jörg Sydow (2002).** "Using Networks Towards Global Labor Standards? Organizing Social Responsibility In Global Production Chains". In: Industrielle Beziehungen, 9. Jg., Heft 4, pp. 357–380.
- FLO / NEWS / EFTA / IFAT (2005).** "Towards A Coherent Fair Trade Policy: Fair Trade Demands To European Decision Makers". Available online at: <http://www.ifat.org/downloads/advocacy/towardsacoherentefairtradepolicyapril20051.pdf>.
- ICFTU (2000).** "Globalising Social Justice: Trade Unionism In The 21st Century", Brussels.

- ICFTU (2004).** "A Trade Union Guide To Globalisation". 2nd edition, Brussels.
- ILO Governing Body (1998).** "Overview Of Global Developments And Office Activities Concerning The Codes Of Conduct, Social Labelling And Other Private Sector Initiatives Addressing Labour Issues". Geneva.
- ILO Governing Body (1999).** "Further Examination Of Questions Concerning Private Initiatives, Including Codes Of conduct". Geneva.
- ILO (2002a).** "Decent Work And The Informal Economy". Report VI. International Labour Conference, 90th Session, Geneva.
- ILO (2002b).** "Codes Of Conduct And Multinational Enterprises". CD-Rom, Geneva.
- ILO World Commission On The Social Dimension Of Globalisation (2004a).** "A Fair Globalisation: Creating Opportunities For All". Geneva.
- ILO (2004b).** "Economic Security For A Better World". Geneva
- ILO (2005).** "World Employment Report 2004–2005 – Employment, Productivity And Poverty Reduction". Geneva.
- Kerkow, Uwe, Jens Martens and Tobias Schmitt (2003).** "The Limits Of Voluntarism – Corporate Self-Regulation, Multistakeholder Initiatives And The Role Of Civil Society". WEED, Bonn/Berlin.
- Köpke, Ronald and Wolfgang Röhr (2002).** "Documentation: Project Presentation And International Seminar Of The Research Project 'Codes Of Conduct And Monitoring'". Hamburg University of Economics and Politics / Hans Böckler Foundation, Hamburg.
- Mamic, Ivanka (2004).** "Implementing Codes Of Conduct: How Businesses Manage Social Performance In Global Supply Chains". ILO, Geneva.
- Maquila Solidarity Network.** "Codes Memo", 2–4 issues/year since 1999, available online (www.maquilasolidarity.org).
- Merk, Jeroen and Ineke Zeldenrust (2005).** "The Business Social Compliance Initiative (BSCI): A Critical Perspective". Clean Clothes Campaign, Amsterdam. Available online at www.cleanclothes.org/ftp/05-050bsci_paper.pdf.
- Misereor / Brot für die Welt / Friedrich Ebert Stiftung (2000).** „Entwicklungspolitische Wirkungen des Fairen Handels“. Aachen, p. 296.
- Müller, Torsten and Stefan Rüb (2004).** "Towards Internationalisation Of Labour Relations? Global Union Networks And International Framework Agreements: Status Quo and Prospects". European and Global Industrial Relations Research Group, University of Applied Sciences, Fulda/Germany.

- Murray, Jill (2002).** "Corporate Codes Of Conduct And Labour Standards". ILO/ACTRAV. Geneva.
- OECD Working Party of the Trade Committee (1999).** Codes of Corporate Conduct: An Inventory", Paris.
- OECD (2000).** "The OECD Guidelines For Multinational Enterprises". Revision 2000. Paris.
- OECD (2001a).** "Codes Of Conduct – Exploring Their Economic Significance". Paris.
- OECD (2001b).** "Codes Of Corporate Conduct: Expanded Review Of Their Contents". Paris.
- OECD Watch (2005).** "Five Years On: A Review Of The OECD Guidelines And National Contact Points". SOMO, Amsterdam.
- O'Rourke, Dara (2000).** "Monitoring The Monitors: A Critique Of Pricewaterhouse-Cooper's (PwC) Labor Monitoring". Cambridge. Available online (web.mit.edu/dorourke/www.index.html).
- O'Rourke, Dara (2003).** "Outsourcing Regulation: Analyzing Nongovernmental Systems Of Labor Standards And Monitoring". The Policy Studies Journal, Vol. 31, No. 1. pp. 1–29.
- Piepel, Klaus (2001).** "Social Labels And Codes Of Conduct. A Position Paper". Misereor / Brot für die Welt. Fair Trade Policy No. 2. Aachen / Germany.
- Round Table on Codes of Conduct (2004).** "Codes Of Conduct On Social Standards". Eschborn / Germany.
- Scherrer, Christoph and Thomas Greven (2001).** "Global Rules For Trade: Codes Of Conduct, Social Labeling, Workers' Rights Clauses". Münster / Germany.
- Sengenberger, Werner (2002).** "Globalization And Social Progress: The Role And Impact Of International Labour Standards". Friedrich Ebert Stiftung, Bonn.
- UNCTAD (2003).** "World Investment Report 2003". Geneva.
- UNCTAD (2004a).** "World Investment Report 2004". Geneva.
- UNCTAD (2004b).** "Making FDI Work For Sustainable Development". New York / Geneva.
- UNDP (2004).** "Human Development Report 2004". New York.
- UNIDO (2002a).** "Corporate Social Responsibility – Implications For Small And Medium Enterprises In Developing Countries". Vienna.
- UNIDO (2002b).** "Corporate Social Responsibility And Developing Country SMEs". Vienna.
- UN Non-Governmental Liaison Service / UNRISD (2002).** "Voluntary Approaches To Corporate Responsibility". Readings and a Resource Guide". NGLS Development Dossier, Geneva.
- UNRISD (2004a).** "Corporate Social Responsibility and Business Regulation", Geneva.
- UNRISD (2004b).** "Corporate Social Responsibility And Development: Towards A New Agenda?". Conference News, Report of the UNRISD Conference Geneva, 17–18 November 2003. UNRISD, Geneva.
- Utting, Peter (2000).** "Business Responsibility For Sustainable Development". Occasional Paper Nor. 2, UNRISD, Geneva.
- Utting, Peter (2002).** "Regulating Business via Multistakeholder Initiatives: A Preliminary Assessment". In: Voluntary Approaches to Corporate Responsibility. Readings and a Resource Guide, UN Non-Governmental Liaison Service/UNRISD, Geneva, p. 116
- Utting, Peter (2005).** "Rethinking Business Regulation: From Self-Regulation To Social Control". Provisional edition. Geneva.
- Van der Vegt, S.B.A. (2005).** Social Auditing in Bulgaria, Romania and Turkey: Results From Survey And Case Study Research". ILO, Geneva.
- Verweij, Myrthe (2002).** "Using The OECD Guidelines For Multinational Enterprises". A critical starterkit for NGOs. Friends of the Earth Netherlands, Amsterdam.
- Wick, Ingeborg (2000).** "The Exception And The Rule – The Relationship Between Formal Ind Informal Employment". in: Shadow Economy and Trade Unions, DGB Bildungswerk Materialien Nr. 71, Düsseldorf.
- World Bank (2003a).** "Company Codes Of Conduct And International Standards: An Analytical Comparison". Washington.
- World Bank (2003b).** "Strengthening Implementation Of Corporate Social Responsibility In Global Supply Chains". Washington.

Contact addresses

Friedrich Ebert Stiftung

Godesberger Allee 149
D 53175 Bonn
Federal Republic of Germany
Telephone: +49-(0)-228-883-517
Telefax: +49-(0)-228-883-623
e-mail: Erwin.Schweisshelm@fes.de
website: www.fes.de

SÜDWIND

Institut für Ökonomie und Ökumene
Lindenstr. 58-60
D 53721 Siegburg
Federal Republic of Germany
Telephone: +49-(0)-2241-259530
Telefax: +49-(0)-2241-51308
e-mail: wick.suedwind@t-online.de
website: www.suedwind-institut.de

Business Social Compliance Initiative (BSCI)

c/o Foreign Trade Association
Avenue de Cortenbergh 168
B 1000 Brussels
Telephone : +32-2-762 0551
Telefax: +32-2-762 7506
e-mail: info@fta-eu.org
website: www.bsci-eu.org

European Commission

CSR DG Employment Team
DG Employment, Social Affairs & Equal Opportunities
B 1049 Brussels
Telephone: +32-2-295 80 57
Telefax: +32-2-296 97 71
e-mail: csr@cec.eu.int
website: <http://europa.eu.int/comm/csr>

Clean Clothes Campaign (CCC)

International Secretariat
P.O. Box 11584
NL 1001 GN Amsterdam
The Netherlands
Telephone: +31-20-412 2785
Telefax: +31-20-412 2786
e-mail: info@cleanclothes.org
website: www.cleanclothes.org

European Fair Trade Association (EFTA)

Kerkewegje 1
NL 6305 BC Schin op Geul
The Netherlands
Telephone: +31-43-325 6917
Telefax: +31-43-325 8433
e-mail: epta@antenna.nl
website: www.eftafairtrade.org

Ethical Trading Initiative (ETI)

2nd Floor, Cromwell House
14 Fulwood Place
London Wc1V 6HZ
United Kingdom
Telephone: +44-20-7404 1463
Telefax: +44-20-7831 7852
e-mail: eti@eti.org.uk
website: www.ethicaltrade.org

European Parliament

Richard Howitt MEP
Rapporteur
13G246 European Parliament
Rue Wiertz
B 1047 Brussels
Belgium
Telephone: +32-2-284 5477
Telefax: +32-2-284 9477
e-mail: rhowitt@europarl.eu.int

Fairtrade Labelling Organisations International (FLO)

Kaiser-Friedrich-Str. 13
D 53113 Bonn
Germany
Telephone: +49-228-949 230
Telefax: +49-228-242 1713
e-mail: info@fairtrade.net
website: www.fairtrade.net

Fair Labor Association (FLA)

1505 22nd Street, NW
Washington, DC 20037
USA
Telephone: +1-202-898 1000
Telefax: +1-202-898 9050
e-mail: tufts@fairlabor.org
website: www.fairlabor.org

Fair Wear Foundation (FWF)

Koningin Wilhelminaplein 13
World fashion Centre
Postbus 69265
1060 CH Amsterdam
Telephone: +31-20-408 4255
Telefax: +31-20-408 4554
e-mail: info@fairwear.nl
website: www.fairwear.nl

Global Compact

Executive Office of the Secretary-General
United Nations
New York, NY 10017
USA
Telephone: +1-212-963 1490
e-mail: globalcompact@un.org
Website: www.unglobalcompact.org

International Confederation of Free Trade Unions (ICFTU)

Boulevard du Roi Albert II 5
B 1210 Brussels
Telephone: +32-2-224 0211
Telefax: +32-2-201 5815
e-mail: multinationals@icftu.org
website : www.icftu.org

International Fair Trade Association (IFAT)

Prijssestraat 24
4101 CR Culemborg
The Netherlands
Telephone: +31-345-535914
Telefax: +31-847-474410
e-mail info@ifat.org
website www.ifat.org

International Labour Organisation (ILO)

4, route des Morillons
CH 1211 Geneva 22
Switzerland
Telephone: +41-22-799 7940
Telefax: +41-22-799 8577
e-mail: webinfo@ilo.org
website: www.ilo.org

International Textile, Garment & Leather Workers' Federation (ITGLWF)

8, rue Joseph Stevens
B 1000 Brussels
Belgium
Telephone: +32-2-5122606
Telefax: +32-2-5110 904
e-mail: office@itglwf.org
website: www.itglwf.org

**Joint Initiative on Corporate
Accountability**

& Workers' Rights
2nd Floor, Cromwell House
14 Fulwood Place
London WC1V 6HZ
United Kingdom
Telephone: +44-20-7404 1463
Telefax: +44-20-7831 7852
e-mail: info@jo-in.org
website: www.jo-in.org

Maquila Solidarity Network

606 Shaw Street
Toronto, ON, M6G 3L6
Canada
Telephone: +1-416-532-8584
Telefax: +1-416-532-7688
e-mail: info@maquilasolidarity.org
website: www.maquilasolidarity.org

**Network of European World Shops
(NEWS)**

Christofsstr. 13
55116 Mainz
Germany
Telephone: +49-6131-9066 410
e-mail: office@worldshops.org
website www.worldshops.org

**Organisation for Economic Co-
Operation and Development (OECD)**

Head of Publications Service
2 rue André Pascal
F 75775 Paris Cedex 16
France
Telephone: +33-1-45248200
Telefax: +33-1-45248500
Website: www.oecd.org

**Social Accountability International
(SAI)**

220 East 23rd street, Suite 605
New York NY 10010
USA
Telephone: +1-212-684-1414
Telefax: +1-212-684-1515
e-mail: info@SAI.org
website: www.sa-intl.org

**United Nations Research Office for
Social Development (UNRISD)**

Palais des Nations
1211 Geneva 10
Switzerland
Telephone : +41-22-9171 143
Telefax: +41-22-9170 650
e-mail: bovay@unrisd.org
website: unrisd.org

Worker Rights Consortium (WRC)

5 Thomas Circle NW, First Floor
Washington, DC 20005
USA
Telephone: +1-202-387 4884
Telefax: +1-202-387 3292
e-mail: wrc@workersrights.org
website : www.workersrights.org

**Worldwide Responsible Apparel
Production (WRAP)**

2200 Wilson Boulevard
Suite 601
Arlington, VA 22201
USA
Telephone: +1-730-243 0970
Telefax: +1-703-243 8247
e-mail: info@wrapapparel.org
website: www.wrapapparel.org

SÜDWIND INSTITUT FÜR ÖKONOMIE UND ÖKUMENE

The SÜDWIND Institut für Ökonomie und Ökumene ("South Wind Institute of Economics and Ecumenism") is a church-oriented third world research center which was founded in 1991 in Cologne/Germany. SÜDWIND analyses different sectors of the world economy from the perspective of the poor and develops options for change. It closely cooperates with similar organisations, trade unions, womens' groups etc. in countries of the South and the North.

Current research topics are:

- Debt cancellation of developing countries and international financial markets
- Socially responsible investment
- Social standards in the world trade
- Child labour in India
- Informal work/economy



FRIEDRICH-EBERT-STIFTUNG

The Friedrich-Ebert-Stiftung is a non-governmental, non-profit organisation committed to the ideas and basic values of social democracy and the labour movement. It bears the name of Germany's first democratically elected president, Friedrich Ebert, and continues to pursue his legacy of building freedom, democracy and social justice, both in Germany and internationally. International cooperation and dialogue is mainly organised through an extensive network of more than 100 field offices around the world



Workers' tool or PR ploy?

A guide to codes of international labour practice

By Ingeborg Wick

Since the early 1990s, codes of conduct for multinational corporations have been proliferating. It is increasingly difficult to distinguish between the different code models. Workers all over the world are confronted with new instruments which claim to improve their labour conditions.

What are the pros and cons of codes of conduct? In which way can they be useful instruments for trade unions? How can trade unions and non-governmental organisations cooperate with regard to codes of conduct? What are the main features of current code examples and the results of a comparison between them ?

This brochure concentrates on profiles of the code verification bodies Fair Wear Foundation, Ethical Trading Initiative, Fair Labor Association, Social Accountability International, Worker Rights Consortium and a comparison between them. Next to an outline of the socio-economic context and other trade-related initiatives, this publication also contains an analysis of the trade union perspectives on codes of conduct by the International Confederation of Free Trade Unions and the International Textile, Garment & Leather Workers' Federation.

